



SINCE 1998



2024/25

**SMARTER
LIGHTING
CHOICES**



A diverse selection of LED interior architectural pendants and wall mount luminaires, ideal for residential and commercial spaces.

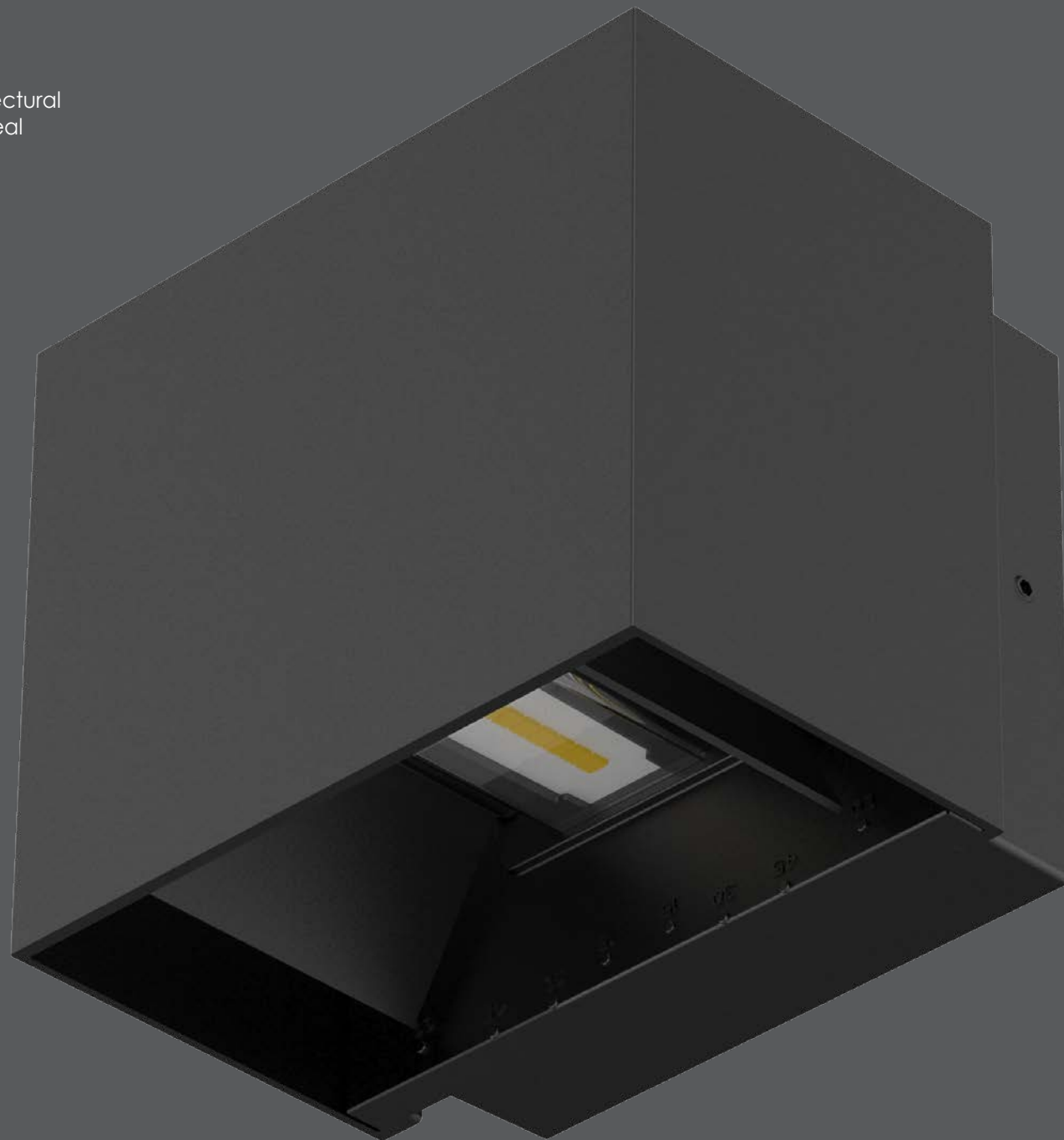
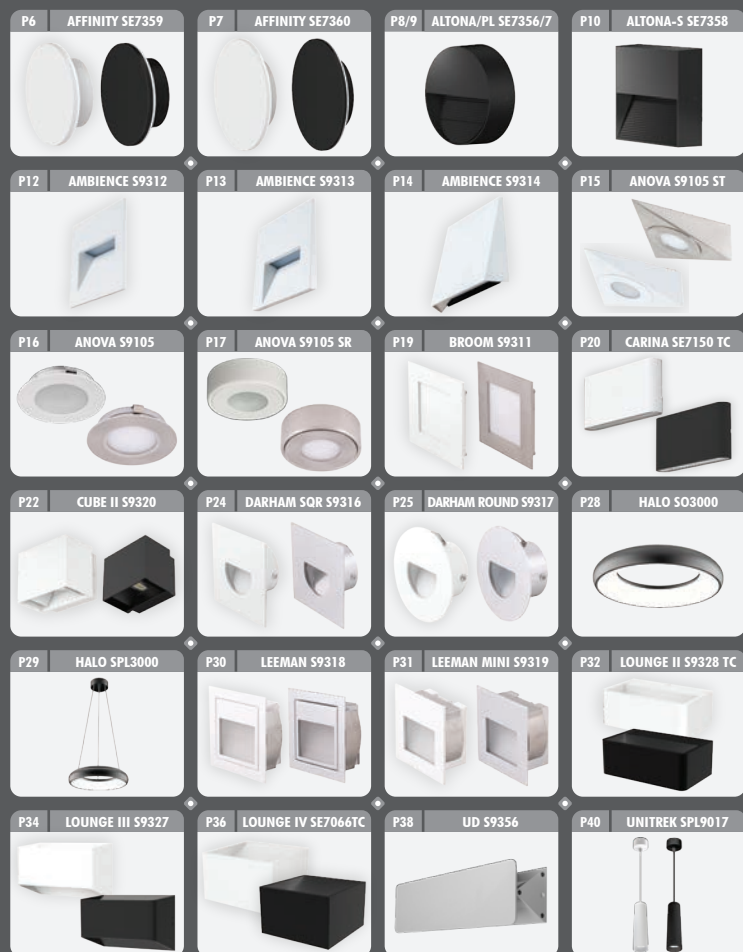



TC SELECTABLE COLOUR



AFFINITY SE7359TC - 8W

Dimmable, 8 watt LED circular profile, IP65 wall mount with selectable CCT

Application

Residential or commercial feature walkways and facades

Design Specifications

- Stylish, indirect optical design
- Durable aluminium circular profile, choice of white or black
- IP65 for interior or exterior use
- Integral flickerCONTROLLED LED control gear
- Selectable CCT, CRI>80
- IK06



Dimensions

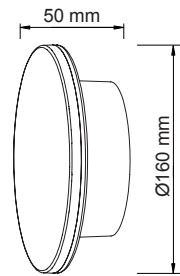

Performance

- Dimmable - Trailing edge



Photometric Data SE7359TC at 4000K

Unit: cd C0/C180 — C90/C270

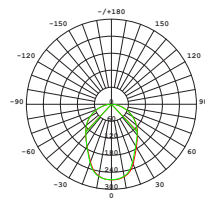

Technical Specifications

Model No.	Input (V)/(Hz)	Power (W)	Lumen (lm)	CCT (K)	Beam Angle	Fitting Colour	Dimensions (D x H mm)
SE7359TC/WH	240/50	8	530/600/590	3000/4000/5700	90°	White	Ø160 x 50
SE7359TC/BK	240/50	8	530/600/590	3000/4000/5700	90°	Black	Ø160 x 50



TC SELECTABLE COLOUR



AFFINITY SE7360TC - 15W

Dimmable, 15 watt LED circular profile, IP65 wall mount with selectable CCT

Application

Residential or commercial feature walkways and facades

Design Specifications

- Stylish, indirect optical design
- Durable aluminium circular profile, choice of white or black
- IP65 for interior or exterior use
- Integral flickerCONTROLLED LED control gear
- Selectable CCT, CRI>80
- IK06

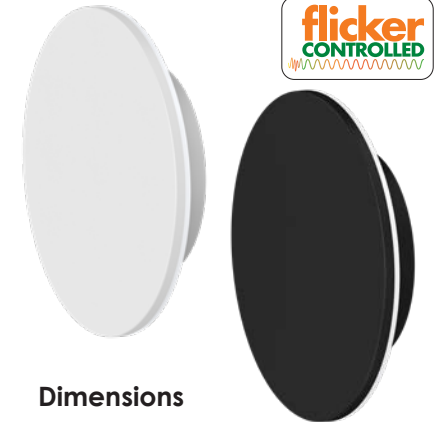

Dimensions

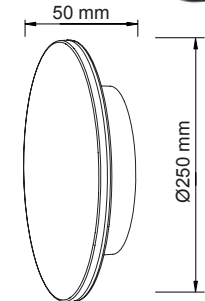

Performance

- Dimmable - Trailing edge



Photometric Data SE7360TC at 4000K

Unit: cd C0/C180 — C90/C270

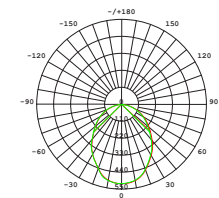

Technical Specifications

Model No.	Input (V)/(Hz)	Power (W)	Lumen (lm)	CCT (K)	Beam Angle	Fitting Colour	Dimensions (D x H mm)
SE7360TC/WH	240/50	15	1100/1200/1150	3000/4000/5700	90°	White	Ø250 x 50
SE7360TC/BK	240/50	15	1100/1200/1150	3000/4000/5700	90°	Black	Ø250 x 50



For interior products, the IP rating stated is from below the ceiling

For terms of catalogue data use, refer to INDEX



sal.net.au



ALTONA SE7356 - 5W

LED 5 watt surface mount, circular profile wall luminaire.

Application

Residential stairs, walkways and interior commercial features

Design Specifications

- Durable aluminium body profile
- Matt black powder coat finish
- High efficiency SMD optics
- CCT choice of 3000K or 5000K
- Integral flickerCONTROLLED LED control gear



Dimensions

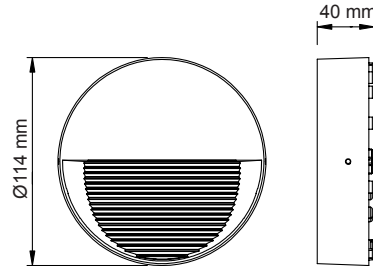

Performance

- Non-dimmable



Photometric Data SE7356WW at 3000K

Unit: cd C0/C180 — C90/C270

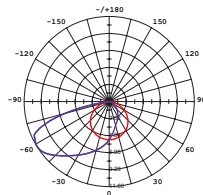

Technical Specifications

Model No.	Input (V)/(Hz)	Power (W)	Lumen (lm)	CCT (K)	CRI	Beam Angle	Fitting Colour	Dimensions (D x H mm)
SE7356WW/BK	240/50	5	150	3000	> 80	60°	Black	Ø114 x 40
SE7356NDL/BK	240/50	5	220	5000	> 80	60°	Black	Ø114 x 40



ALTONA PLUS SE7357 - 8W

LED 8 watt surface mount, circular profile wall luminaire.

Application

Residential stairs, walkways and interior commercial features

Design Specifications

- Durable aluminium body profile
- Matt black powder coat finish
- High efficiency SMD optics
- CCT choice of 3000K or 5000K
- Integral flickerCONTROLLED LED control gear



Dimensions

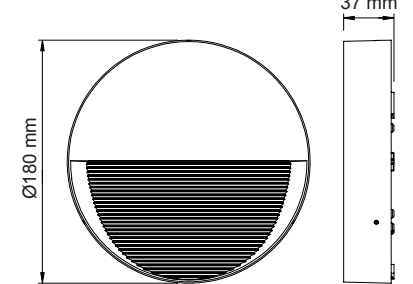

Performance

- Non-dimmable



Photometric Data SE7357WW at 3000K

Unit: cd C0/C180 — C90/C270

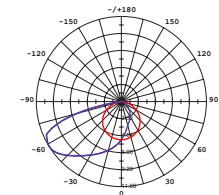

Technical Specifications

Model No.	Input (V)/(Hz)	Power (W)	Lumen (lm)	CCT (K)	CRI	Beam Angle	Fitting Colour	Dimensions (D x H mm)
SE7357WW/BK	240/50	8	350	3000	> 80	60°	Black	Ø180 x 37
SE7357NDL/BK	240/50	8	500	5000	> 80	60°	Black	Ø180 x 37



For interior products, the IP rating stated is from below the ceiling

For terms of catalogue data use, refer to INDEX





ALTONA-S SE7358 - 5W

LED 5 watt surface mount, square profile wall luminaire.

Application

Residential stairs, walkways and interior commercial features

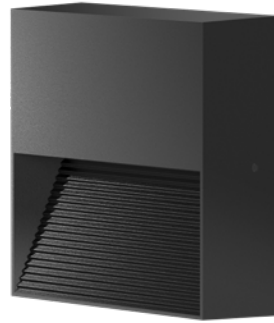

Design Specifications

- Durable aluminium body profile
- Matt black powder coat finish
- High efficiency SMD optics
- CCT choice of 3000K or 5000K
- Integral flickerCONTROLLED LED control gear

Dimensions

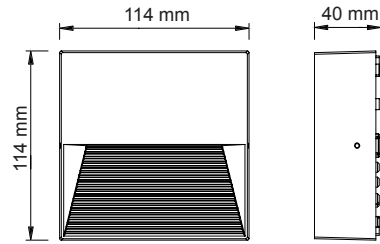

Performance

- Non-dimmable



Photometric Data SE7358 at 3000K

Unit: cd C0/C180 — C90/C270

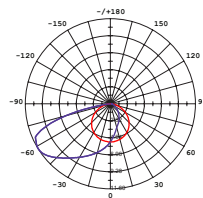

Technical Specifications

Model No.	Input (V)/(Hz)	Power (W)	Lumen (lm)	CCT (K)	CRI	Beam Angle	Fitting Colour	Dimensions (L x W x H mm)
SE7358WW/BK	240/50	5	150	3000	> 80	60°	Black	114 x 114 x 40
SE7358NDL/BK	240/50	5	220	5000	> 80	60°	Black	114 x 114 x 40

For interior products, the IP rating stated is from below the ceiling



Image courtesy of QCE, photography Indie Lane Tourquay

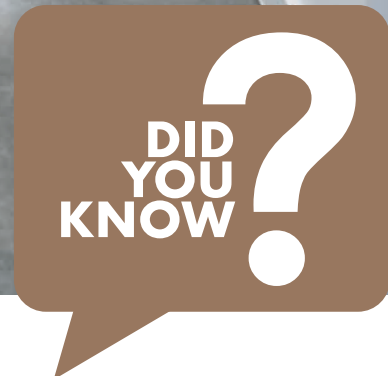

Before selecting a luminaire, look for the marks of Compliance and Safety. Starting with the RCM mark, this signals that the product has been tested to all relevant Australian Safety standards, to ensure the product delivers its designed safety performance.

AMBIENCE S9312 - 1W

Stylish interior wall mount LED luminaire

Application

Residential hallways, bedrooms, stairways

Design Specifications

- Square aluminum face profile, powder coat white finish
- Integral 240V control gear
- CCT 3000K, 40lm
- IP54 front only
- Cut out: 77 x 77mm
- Double insulated

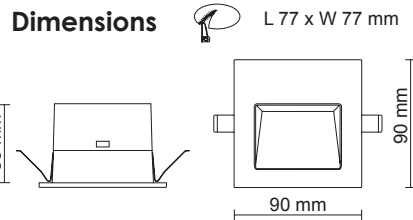

Performance

- Non-dimmable



Photometric Data S9312 at 3000K

Unit: cd C0/C180 — C90/C270

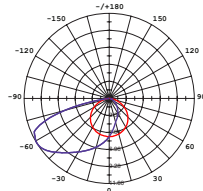

Technical Specifications

Model No.	Input (V)/(Hz)	Power (W)	Lumen (lm)	CCT (K)	CRI	Beam Angle	Dimmable	Fitting Colour
S9312	240/50	1	40	3000	> 80	80°	No	White

For interior products, the IP rating stated is from below the ceiling

AMBIENCE S9313 - 1W

Stylish interior wall mount LED luminaire

Application

Residential hallways, bedrooms, stairways

Design Specifications

- Square aluminum face profile, powder coat white finish
- Integral 240V control gear
- CCT 3000K, 40lm
- IP54 front only
- Cut out: 77 x 77mm
- Double insulated

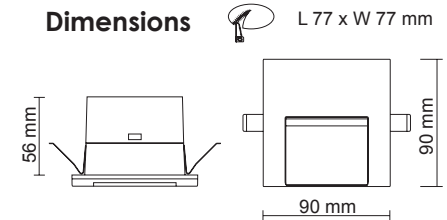

Performance

- Non-dimmable



Photometric Data S9313 at 3000K

Unit: cd C0/C180 — C90/C270

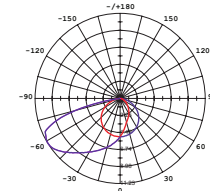

Technical Specifications

Model No.	Input (V)/(Hz)	Power (W)	Lumen (lm)	CCT (K)	CRI	Beam Angle	Dimmable	Fitting Colour
S9313	240/50	1	40	3000	> 80	80°	No	White

For terms of catalogue data use, refer to INDEX

AMBIENCE S9314 - 1W

Stylish interior wall mount LED luminaire

Application

Residential hallways, bedrooms, stairways

Design Specifications

- Square aluminum face profile, powder coat white finish
- Integral 240V control gear
- CCT 3000K, 40lm
- IP54 front only
- Cut out: 77 x 77mm
- Double insulated

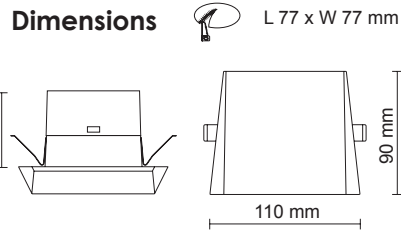

Performance

- Non-dimmable



Photometric Data S9314 at 3000K

Unit: cd C0/C180 — C90/C270

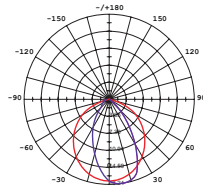

Technical Specifications

Model No.	Input (V)/(Hz)	Power (W)	Lumen (lm)	CCT (K)	CRI	Beam Angle	Dimmable	Fitting Colour
S9314	240/50	1	40	3000	> 80	80°	No	White

ANOVA ST S9105 - 4W

Compact 4 watt surface mount LED cabinet luminaire

Application

Ideal for any residential or commercial feature lighting



Design Specifications

- Durable die-cast aluminium body profile
- White powder coat or satin nickel finish
- High efficiency LED optics
- CCT choice of 3000K or 6000K
- 12V DC remote driver required, suitable drivers - PLUTO EGL12V/6W, PLUTO 15DV, 40DV, 60DV

Dimensions

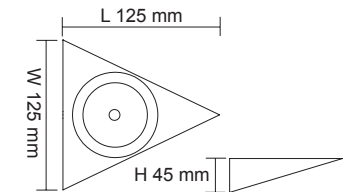

Performance

- Non-dimmable



Photometric Data S9105WW ST at 3000K

Unit: cd C0/C180 — C90/C270

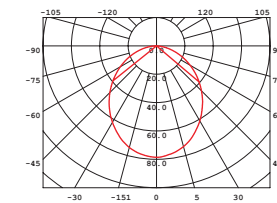

Technical Specifications

Model No.	Input (V)	Power (W)	Lumen (lm)	CCT (K)	CRI	Beam Angle	Dimmable	Fitting Colour
S9105WW ST/WH	12V DC	4	280	3000	> 80	90°	No	White
S9105DL ST/WH	12V DC	4	280	6000	> 80	90°	No	White
S9105WW ST/SN	12V DC	4	280	3000	> 80	90°	No	Satin Nickel
S9105DL ST/SN	12V DC	4	280	6000	> 80	90°	No	Satin Nickel

For terms of catalogue data use, refer to INDEX

ANOVA S9105 - 4W

Compact 4 watt recessed LED cabinet luminaire

Application

Ideal for any residential or commercial interior space

Design Specifications

- Durable die-cast aluminium body profile
- White powder coat or satin nickel finish
- High efficiency SMD optics
- CCT choice of 3000K / 4000K / 6000K
- 12V DC LED driver required, suitable drivers - PLUTO EGL12V/6W, PLUTO 15DV, 40DV, 60DV

Performance

- Non-dimmable



Technical Specifications

Model No.	Input (V)	Power (W)	Lumen (lm)	CCT (K)	CRI	Beam Angle	Dimmable	Fitting Colour
S9105WW/WH	12V DC	4	280	3000	> 80	90°	No	White
S9105CW/WH	12V DC	4	280	4000	> 80	90°	No	White
S9105DL/WH	12V DC	4	280	6000	> 80	90°	No	White
S9105WW/SN	12V DC	4	280	3000	> 80	90°	No	Satin Nickel
S9105CW/SN	12V DC	4	280	4000	> 80	90°	No	Satin Nickel
S9105DL/SN	12V DC	4	280	6000	> 80	90°	No	Satin Nickel



Dimensions Ø 60 mm

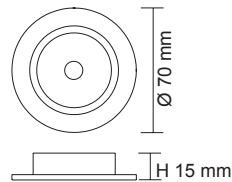

Photometric Data S9105WW at 3000K

Unit: cd C0/C180 — C90/C270

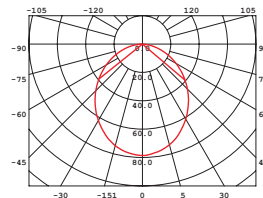

ANOVA SR S9105 - 4W

Compact 4 watt surface mount LED cabinet luminaire

Application

Ideal for any residential or commercial interior space

Design Specifications

- Durable die-cast aluminium downlight profile and aluminium surface mount can
- White powder coat or satin nickel finish
- High efficiency SMD optics
- CCT choice of 3000K / 6000K
- 12V DC LED driver required, suitable drivers - PLUTO EGL12V/6W, PLUTO 15DV, 40DV, 60DV

Performance

- Non-dimmable



Technical Specifications

Model No.	Input (V)	Power (W)	Lumen (lm)	CCT (K)	CRI	Beam Angle	Dimmable	Fitting Colour
S9105WW SR/WH	12V DC	4	280	3000	> 80	90°	No	White
S9105DL SR/WH	12V DC	4	280	6000	> 80	90°	No	White
S9105WW SR/SN	12V DC	4	280	3000	> 80	90°	No	Satin Nickel
S9105DL SR/SN	12V DC	4	280	6000	> 80	90°	No	Satin Nickel



Dimensions

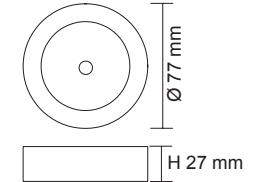

Photometric Data S9105WW SR at 3000K

Unit: cd C0/C180 — C90/C270

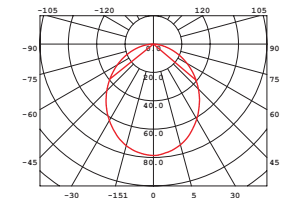



BROOM S9311 - 3W

Recessed 3 watt LED square profile wall luminaire

Application

Ideal for any residential or commercial interior space

Design Specifications

- Durable aluminium body profile
- White powder coat or satin nickel finish
- High efficiency SMD optics, beam distribution 105°
- CCT 3000K, CRI >80
- Opal acrylic diffuser
- 12V AC or DC remote driver required, suitable drivers - PLUTO EGL12V/6W, PLUTO 15DV, 40DV, 60DV

Performance

- Non-dimmable



Dimensions L 76 x W 76 mm

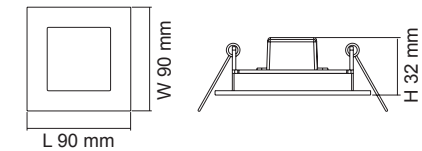

Photometric Data

S9311 at 3000K
Unit: cd C0/C180 — C90/C270

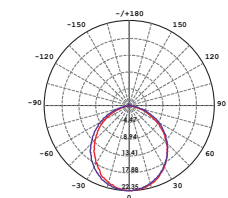

Technical Specifications

Model No.	Input (V)	Power (W)	Lumen (lm)	CCT (K)	CRI	Beam Angle	Dimmable	Fitting Colour
S9311 WH	12V AC/DC	3	110	3000	> 80	105°	No	White
S9311 SN	12V AC/DC	3	110	3000	> 80	105°	No	Satin Nickel

For terms of catalogue data use, refer to INDEX

Image courtesy of





TC SELECTABLE COLOUR



CARINA SE7150 TC - 10W

LED 10 watt surface mount wall luminaire, with selectable CCT

Application

Residential and commercial interior and exterior wall features

Design Specifications

- Durable aluminium body profile
- Matt black or white powder coat finish
- High efficiency LED optics
- Selectable CCT 3000 / 4000 / 5700K
- Precise UP/DOWN beam distribution 8°
- Integral flickerCONTROLLED LED control gear



Dimensions

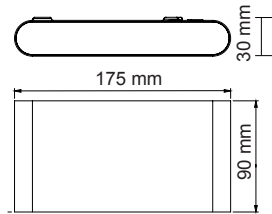

Photometric Data SE7150/10TC at 4000K

Unit: cd C0/C180 C30/C210
C60/C240 C90/C270

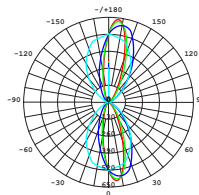

Performance

- Non-dimmable



Technical Specifications

Model No.	Input (V)/(Hz)	Power (W)	Lumen (lm)	CCT (K)	CRI	Fitting Colour
SE7150/10TC/WH	240/50	10	950/1050/1000	3000/4000/5700	> 80	White
SE7150/10TC/BK	240/50	10	950/1050/1000	3000/4000/5700	> 80	Black



For interior products, the IP rating stated is from below the ceiling



Why is the IP rating of a luminaire so important?

IP (Ingress Protection) ratings are found in AS60529 and simply define the ability of an electrical product to seal & protect against the intrusion of foreign objects & water.



How does the rating system work?

Two numerals determine the rating, the first numeral stands for **(I)** intrusion of a foreign object, where the second numeral stands for **(P)** penetration of water. As a guide **IP20** rated products would be found in interior spaces with no requirement for protection against the elements, where an **IP65** product would be found in an exterior application, which requires substantial protection against the elements.

First Digit	Intrusion Protection	Second Digit	Water Protection
0	No specific protection	0	No specific protection
1	Protected against solid objects over 50mm, e.g. accidental contact of hands	1	Protected against vertically falling drops of water
2	Protected against solid objects over 12mm, e.g. contact with finger	2	Protected against direct sprays of water up to 15 degrees from the vertical
3	Protected against solid objects over 2.5mm, e.g. tools & wires	3	Protected against direct sprays of water up to 60 degrees from the vertical
4	Protected against solid objects over 1mm, e.g. wires & nails	4	Protected against water splashed from all directions, limited ingress permitted
5	Protected against dust limited ingress, no harmful deposits	5	Protected against low pressure jets of water from all directions
6	Totally protected against dust	6	Protected against strong jets of water
		7	Protection from temporary immersion
		8	(water tight), protection from continuous submersion
		9K	Protection against close range, high pressure and high temperature spray



CUBE II S9320 - 10W

10 watt LED surface mount CUBE
profile wall luminaire

Application

Ideal for any residential or
commercial interior or exterior space



Design Specifications

- Durable aluminium body profile
- Powder coat finish, colour black or white
- High efficiency SMD optics
- CCT choice of 3000K / 5000K
- Independent up & down beam, adjustable from 10° to 60°
- Integral non-dimmable LED driver

Dimensions

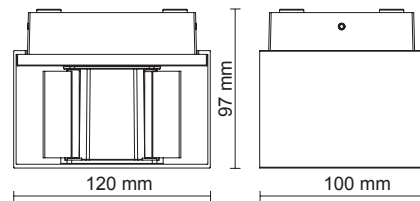

Performance

- Non-dimmable



Photometric Data S9320WW at 3000K

Unit: cd C0/C180 C30/C210
C60/C240 C90/C270

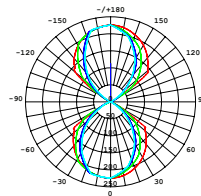

Technical Specifications

Model No.	Input (V)/(Hz)	Power (W)	Lumen (lm)	CCT (K)	CRI	Dimmable	Fitting Colour
S9320WW/WH	240/50	10	750	3000	> 80	No	White
S9320WW/BK	240/50	10	750	3000	> 80	No	Black
S9320NDL/WH	240/50	10	900	5000	> 80	No	White
S9320NDL/BK	240/50	10	900	5000	> 80	No	Black

For interior products, the IP rating stated is from below the ceiling

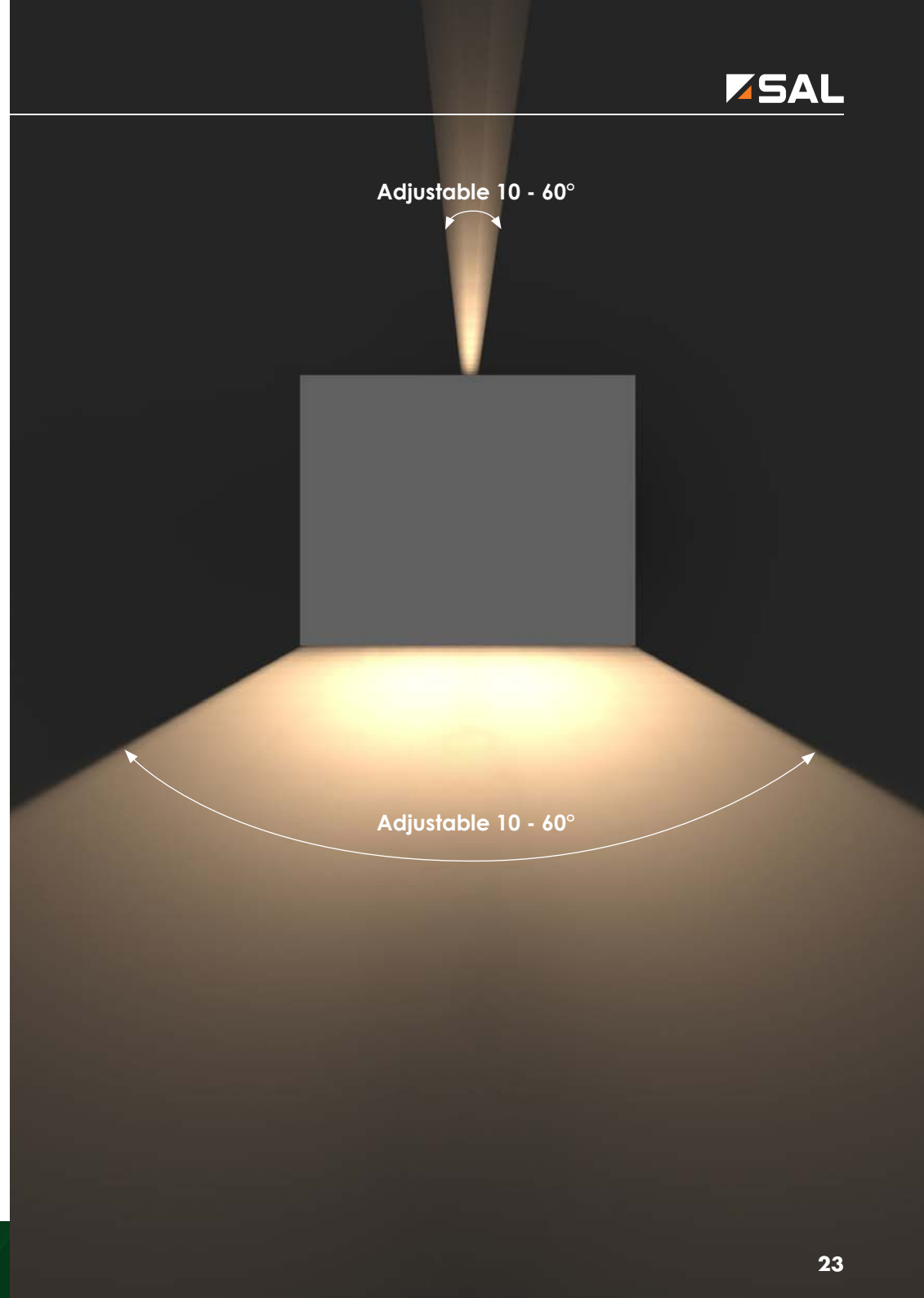

DARHAM SQUARE S9316 - 1.5W

LED 1.5 watt recessed square profile wall luminaire

Application

Ideal for any residential stairs, walkways or commercial interior space

Design Specifications

- Durable die-cast aluminium body profile
- White powder coat finish or anodized silver
- High efficiency SMD optics, CCT 3000K
- Opal acrylic diffuser with glass cover
- 12V AC or DC driver required, suitable drivers - PLUTO EGL12V/6W PLUTO 15DV, 40DV, 60DV
- Optional pre-install wall box available



Dimensions

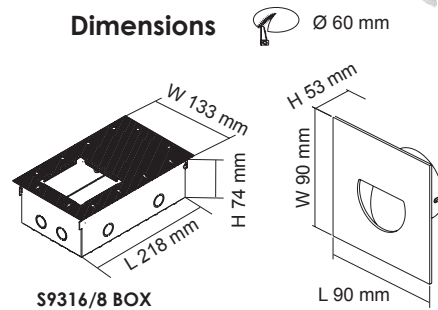

S9316/8 BOX

L 90 mm

Performance

- Non-dimmable



Photometric Data

S9316 at 3000K

Unit: cd C0/C180 — C90/C270

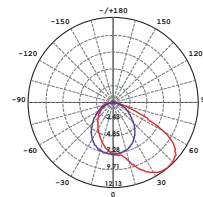

Technical Specifications

Model No.	Input (V)	Power (W)	Lumen (lm)	CCT (K)	CRI	Dimmable	Fitting Colour
S9316 WH	12V AC/DC	1.5	110	3000	> 80	No	White
S9316 ALU	12V AC/DC	1.5	110	3000	> 80	No	Anodized Silver

DARHAM ROUND S9317 - 1.5W

LED 1.5 watt recessed round profile wall luminaire

Application

Ideal for any residential stairs, walkways or commercial interior space

Design Specifications

- Durable die-cast aluminium body profile
- White powder coat finish or anodized silver
- High efficiency SMD optics, CCT 3000K
- Opal acrylic diffuser with glass cover
- 12V AC or DC driver required, suitable drivers - PLUTO EGL12V/6W PLUTO 15DV, 40DV, 60DV



Dimensions

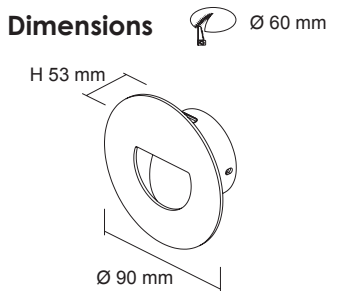

Performance

- Non-dimmable



Photometric Data

S9317 at 3000K

Unit: cd C0/C180 — C90/C270

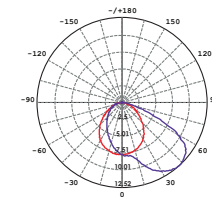

Technical Specifications

Model No.	Input (V)	Power (W)	Lumen (lm)	CCT (K)	CRI	Dimmable	Fitting Colour
S9317 WH	12V AC/DC	1.5	110	3000	> 80	No	White
S9317 ALU	12V AC/DC	1.5	110	3000	> 80	No	Anodized Silver



DARHAM ROUND S9317 - 1.5W

Image courtesy of QCE,
photography Indie Lane Tourquay



HALO SO3000 - 18W/35W

Dimmable architectural LED ceiling luminaire

Application

A creative design for residential or commercial spaces

Design Specifications

- Slim disc like appearance, 18 or 35 watt models
- Durable polycarbonate body profile with opal acrylic diffuser
- Simple twist lock installation mechanism
- High efficiency LED optics
- CCT 4000K, 35watt available in 3000K
- Integral constant current trailing edge dimmable LED driver
- Trim standard black



Dimensions

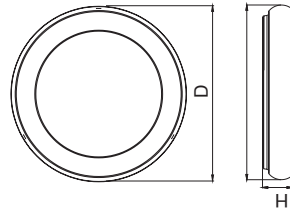

Photometric Data

Unit: cd C0/C180 — C30/C210
C60/C240 — C90/C270

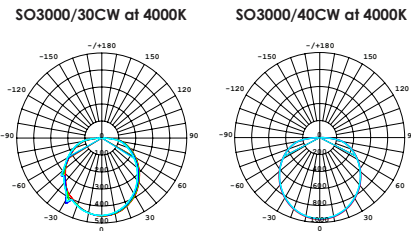

Performance

- Dimmable - Trailing edge



Technical Specifications

Model No.	Input (V)/(Hz)	Power (W)	Lumen (lm)	CCT (K)	CRI	Dimmable	Fitting Colour	Dimensions (D x H mm)
SO3000/30CW	240/50	18	1450	4000	> 80	Yes	Black	Ø 300 x 51
SO3000/40CW	240/50	35	3300	4000	> 80	Yes	Black	Ø 400 x 68

HALO SPL3000 - 18W/35W

Dimmable architectural LED pendant luminaire

Application

A creative design for residential or commercial spaces

Design Specifications

- Slim disc like appearance, 18 or 35 watt models
- Durable polycarbonate body profile with opal acrylic diffuser
- High efficiency LED optics, 18 or 35 watt models
- Integral constant current trailing edge dimmable LED driver
- Suspension kits provided (standard length 1.5 m and adjustable)
- CCT 4000K

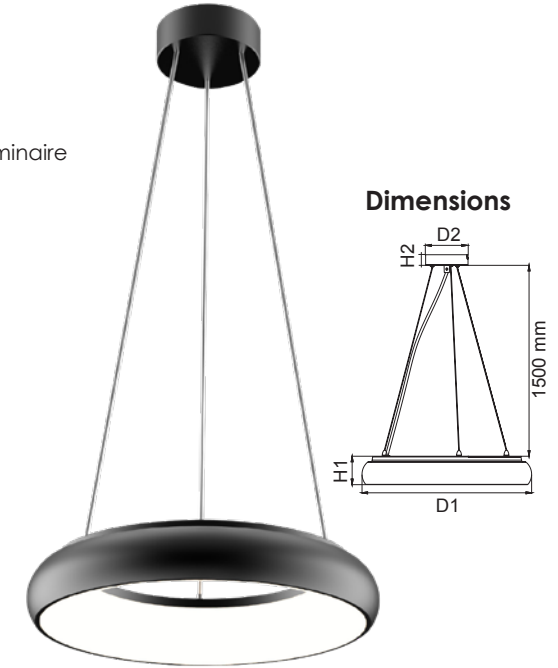

Performance

- Dimmable - Trailing edge



Technical Specifications

Model No.	Input (V)/(Hz)	Power (W)	Lumen (lm)	CCT (K)	CRI	Dimmable	Fitting Colour	Dimensions (D1 x H1, D2 x H2 mm)
SPL3000/30CW	240/50	18	1450	4000	> 80	Yes	Black	Ø 300 x 51, Ø 100 x 25
SPL3000/40CW	240/50	35	3300	4000	> 80	Yes	Black	Ø 400 x 68, Ø 130 x 35

Photometric Data

Unit: cd C0/C180 — C30/C210
C60/C240 — C90/C270

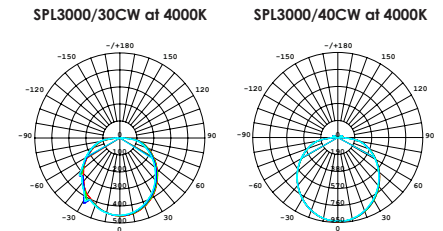

LEEMAN S9318 - 1.5W

LED 1.5 watt recessed square profile and square cut-out wall luminaire

Application

Residential stairs, walkways and interior commercial features

Design Specifications

- Durable aluminium body profile
- Matt white powder coat finish or anodized silver
- High efficiency SMD optics, CCT 3000K, beam distribution 86°
- Frosted glass diffuser
- 12V AC or DC driver required, suitable drivers - PLUTO EGL12V/6W PLUTO 15DV, 40DV, 60DV
- Optional pre-install wall box available



Dimensions

L 68 x W 68 mm

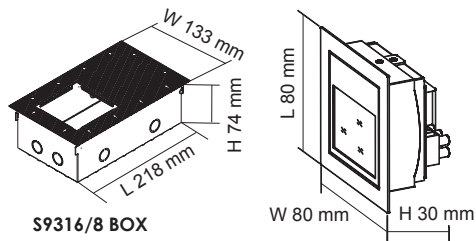

S9316/8 BOX

Performance

- Non-dimmable



Photometric Data

S9318 at 3000K

Unit: cd C0/C180 — C90/C270

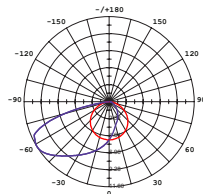

Technical Specifications

Model No.	Input (V)	Power (W)	Lumen (lm)	CCT (K)	CRI	Beam Angle	Fitting Colour
S9318 AS	12V AC/DC	1.5	70	3000	> 80	86°	Anodized Silver
S9318 MW	12V AC/DC	1.5	70	3000	> 80	86°	Matt White

LEEMAN MINI S9319 - 1.5W

LED 1.5 watt recessed MINI square profile and square cut-out wall luminaire

Application

Residential stairs, walkways and commercial features

Design Specifications

- Durable aluminium body profile
- White powder coat finish or anodized silver
- High efficiency SMD optics, CCT 3000K, beam distribution 86°
- Frosted glass diffuser
- 12V AC or DC driver required, suitable drivers - PLUTO EGL12V/6W PLUTO 15DV, 40DV, 60DV



Dimensions

L 50 x W 50 mm

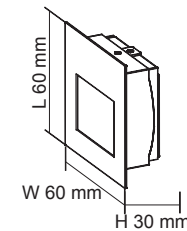

Performance

- Non-dimmable



Photometric Data

S9319 at 3000K

Unit: cd C0/C180 — C90/C270

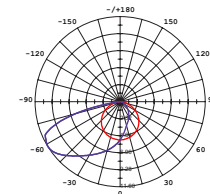

Technical Specifications

Model No.	Input (V)	Power (W)	Lumen (lm)	CCT (K)	CRI	Beam Angle	Fitting Colour
S9319 AS	12V AC/DC	1.5	70	3000	> 80	86°	Anodized Silver
S9319 MW	12V AC/DC	1.5	70	3000	> 80	86°	Matt White

LOUNGE II S9328 TC - 9W/15W

9/15 watt decorative IP54 architectural LED wall mount luminaire, with selectable CCT

Application

An architectural solution for residential & commercial interior or exterior spaces

Design Specifications

- Selectable CCT , 3000K / 4000K / 5000K
- Durable white or black powder coated finish
- Integral non-dimmable control gear
- Robust die-cast aluminium body profile
- High efficiency LED optics
- UP/DOWN optical performance



Performance

- Non-dimmable



Photometric Data

Unit: cd C0/C180 — C90/C270

S9328/150TC at 3000K

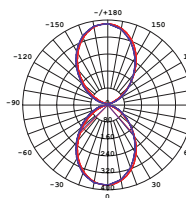

S9328/220TC at 3000K

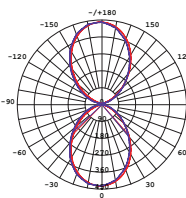

Technical Specifications

Model No.	Input (V)/(Hz)	Power (W)	Lumen (lm)	CCT (K)	CRI	Fitting Colour	Dimensions (L x W x H mm)
S9328/150TC/WH	240/50	9	500/600/550	3000/4000/5000	> 80	White	150 x 90 x 55
S9328/150TC/BK	240/50	9	500/600/550	3000/4000/5000	> 80	Black	150 x 90 x 55
S9328/220TC/WH	240/50	15	800/1000/900	3000/4000/5000	> 80	White	220 x 90 x 55
S9328/220TC/BK	240/50	15	800/1000/900	3000/4000/5000	> 80	Black	220 x 90 x 55

For interior products, the IP rating stated is from below the ceiling



LOUNGE III S9327 - 10W/18W

10/18 watt decorative IP54 architectural LED wall mount luminaire

Application

Ideal for any residential or commercial interior or exterior space

Design Specifications

- Durable aluminium body profile
- White or black powder coat finish
- High efficiency LED optics
- CCT choice of 3000K or 5000K
- UP/DOWN optical performance
- Integral non-dimmable driver

S9327/150 BK



S9327/150 WH



S9327/300 BK



S9327/300 WH

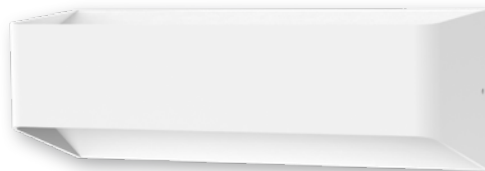

Performance

- Non-dimmable



Photometric Data S9327/300WW at 3000K

Unit: cd C0/C180 — C90/C270

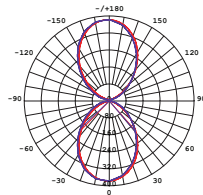

For interior products, the IP rating stated is from below the ceiling

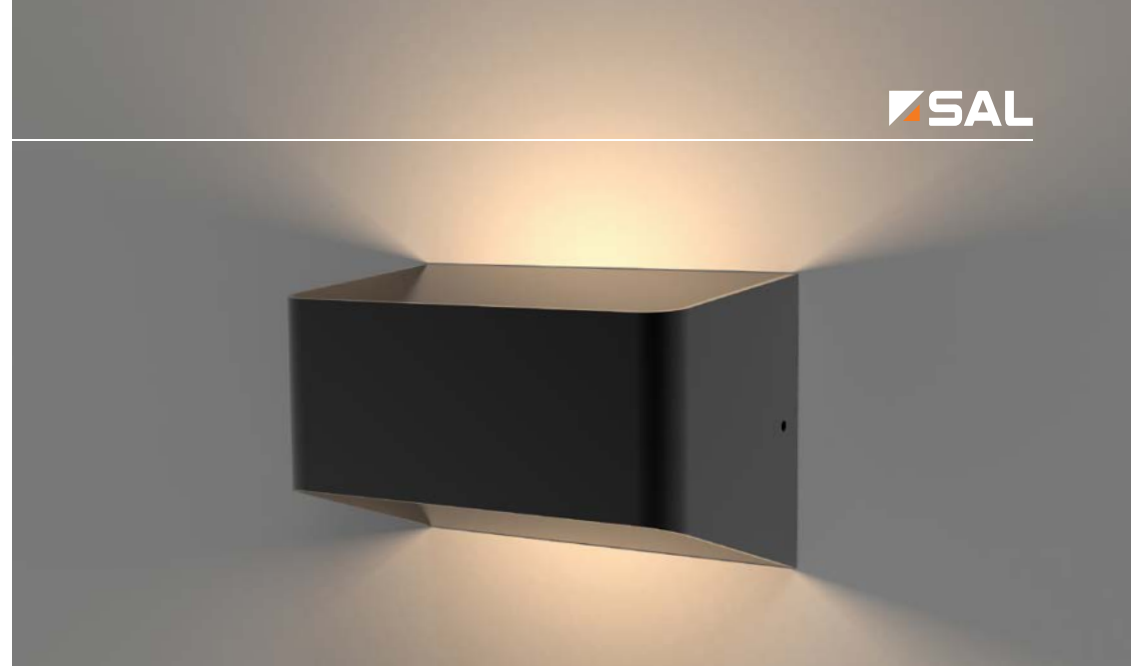

Dimensions

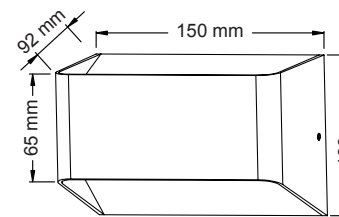

S9327/150

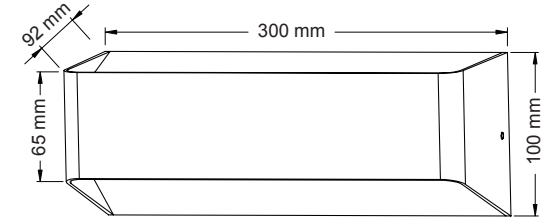

S9327/300

Technical Specifications

Model No.	Input (V)/(Hz)	Power (W)	Lumen (lm)	CCT (K)	CRI	Fitting Colour	Dimensions (L x W x H mm)
S9327/150WW/WH	240/50	10	400	3000	> 80	White	150 x 100 x 92
S9327/150WW/BK	240/50	10	400	3000	> 80	Black	150 x 100 x 92
S9327/150NDL/WH	240/50	10	500	5000	> 80	White	150 x 100 x 92
S9327/150NDL/BK	240/50	10	500	5000	> 80	Black	150 x 100 x 92
S9327/300WW/WH	240/50	18	720	3000	> 80	White	300 x 100 x 92
S9327/300WW/BK	240/50	18	720	3000	> 80	Black	300 x 100 x 92
S9327/300NDL/WH	240/50	18	900	5000	> 80	White	300 x 100 x 92
S9327/300NDL/BK	240/50	18	900	5000	> 80	Black	300 x 100 x 92

For terms of catalogue data use, refer to INDEX



TC SELECTABLE COLOUR

LOUNGE IV SE7066TC - 9W

9 watt decorative IP54 architectural
LED wall mount luminaire

Application

An architectural solution for residential &
commercial interior or exterior spaces

Design Specifications

- Selectable CCT, 3000K/4000K/5000K
- White or black powder coat finish
- High efficiency LED optics
- UP/DOWN optical performance
- Integral non-dimmable driver

Performance

- Non-dimmable

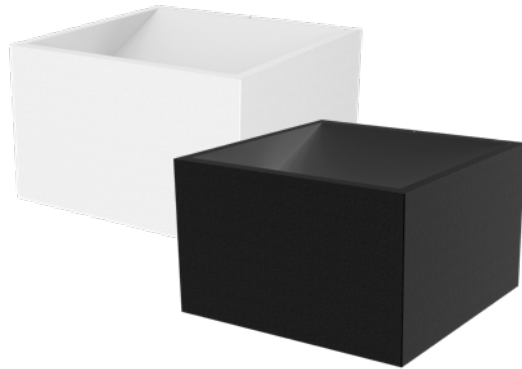

Dimensions

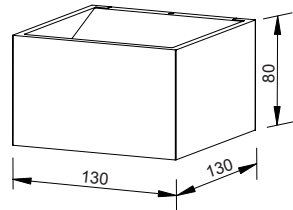

Photometric Data SE7066TC/WH at 4000K

Unit: cd C0/C180 — C90/C270

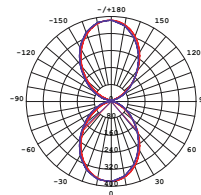

Technical Specifications

Model No.	Input (V)/(Hz)	Power (W)	Lumen (lm)	CCT (K)	CRI	Fitting Colour	Dimensions (L x W x H mm)
SE7066TC/WH	240/50	9	500/600/550	3000/4000/5000	> 80	White	130 x 130 x 80
SE7066TC/BK	240/50	9	500/600/550	3000/4000/5000	> 80	Black	130 x 130 x 80

For interior products, the IP rating stated is from below the ceiling



SCAN ME



SAL YouTube PRODUCT GUIDES, MORE INFORMATION, EASY TO FIND

UD S9356 - 3W/12W

Adjustable LED surface mount profile wall luminaires

Application

Ideal for any residential or commercial interior space

Design Specifications

- Durable aluminium body profile
- White powder coat finish
- High efficiency LED optics, CCT 3000K
- Up & Down beam angle adjustable from -60° to +60°
- Integral non-dimmable LED driver, 3 or 12 watt models

Performance

- Dimmable - optional, trailing edge refer model No.



S9356/160WW/WH

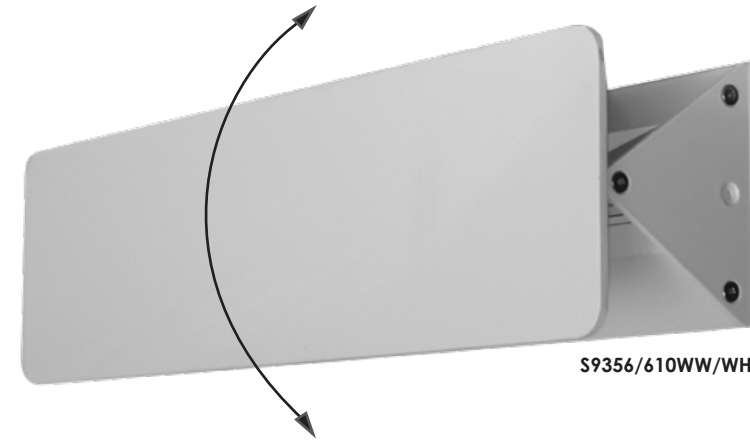

S9356/610WW/WH



Dimensions

S9356/160WW/WH

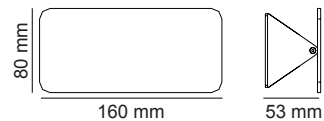

S9356/610WW/WH

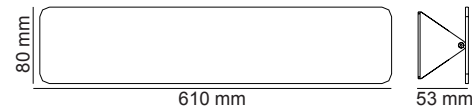

Technical Specifications

Model No.	Input (V)/(Hz)	Power (W)	Lumen (lm)	CCT (K)	CRI	Dimmable	Fitting Colour
S9356/160WW/WH	240/50	3	250	3000	> 80	No	White
S9356/610WW/WH	240/50	12	800	3000	> 80	Optional	White

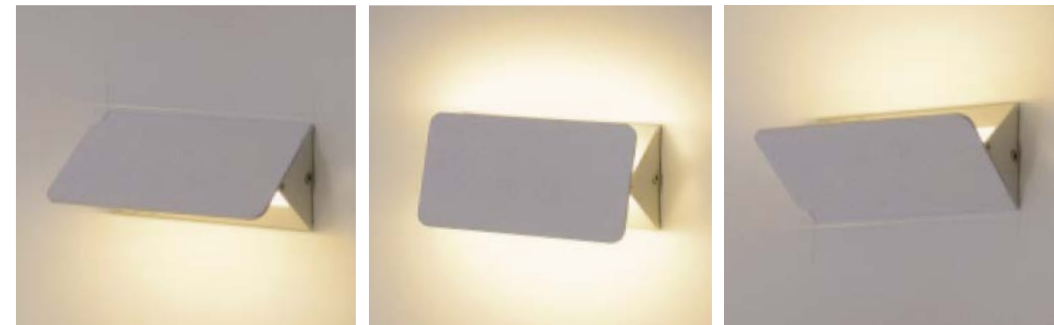

For interior products, the IP rating stated is from below the ceiling

For terms of catalogue data use, refer to INDEX

UNITREK SPL9017 - 9W

Dimmable 9 watt LED pendant luminaire

Application

A creative design for residential or commercial spaces

Design Specifications

- Architectural cylindrical profile, standard colour black, optional white
- Durable aluminium body profile
- High efficiency LED optics, with a polycarbonate optical lens
- Beam distribution 60°, CRI>80
- Integral trailing edge dimmable LED driver
- Standard adjustable wire length up to 1.2 m

Performance

- Dimmable - Trailing edge

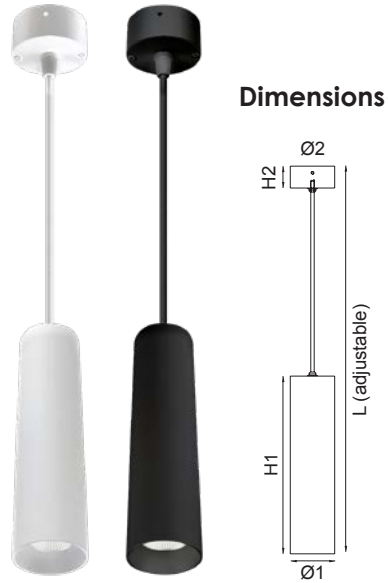

Photometric Data SPL9017WW at 3000K

Unit: cd C0/C180 — C90/C270

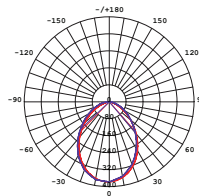

Technical Specifications

Model No.	Input (V)/(Hz)	Power (W)	Lumen (lm)	CCT (K)	CRI	Beam Angle	Fitting Colour	Dimensions (Ø1 x H1, Ø2 x H2 mm)
SPL9017WW/WH	240/50	9	700	3000	> 80	60°	White	65 x 260, 65 x 32
SPL9017WW/BK	240/50	9	700	3000	> 80	60°	Black	65 x 260, 65 x 32
SPL9017CW/WH	240/50	9	800	4000	> 80	60°	White	65 x 260, 65 x 32
SPL9017CW/BK	240/50	9	800	4000	> 80	60°	Black	65 x 260, 65 x 32

For interior products, the IP rating stated is from below the ceiling

PIXIE SMART HOME AUTOMATION.





 SAL National Pty Ltd - 40 Biloela St, Villawood NSW 2163

 + 61 2 9723 3099

 www.sal.net.au

 info@sal.net.au

 VICT/TAS - 46/48 Keys Road Moorabbin VIC 3189

 + 61 3 9532 3168

 info@sal.net.au

 QLD - 36 Whitelaw Place Richlands QLD 4077

 + 61 7 3879 5999

 info@sal.net.au

 SA/NT - Unit 1, 9 Alfred Avenue Beverley SA 5009

 +61 8 7084 1958

 info@sal.net.au

 WA - 29 Beringarra Avenue Malaga WA 6090

 +61 8 9248 7458

 info@sal.net.au



2024/25

