



**SINCE 1998**



**2024/25**

**SMARTER  
LIGHTING  
CHOICES**



An extensive suite of innovative LED Downlights, recessed or surface mount with a wide selection of colours and dimming choices.

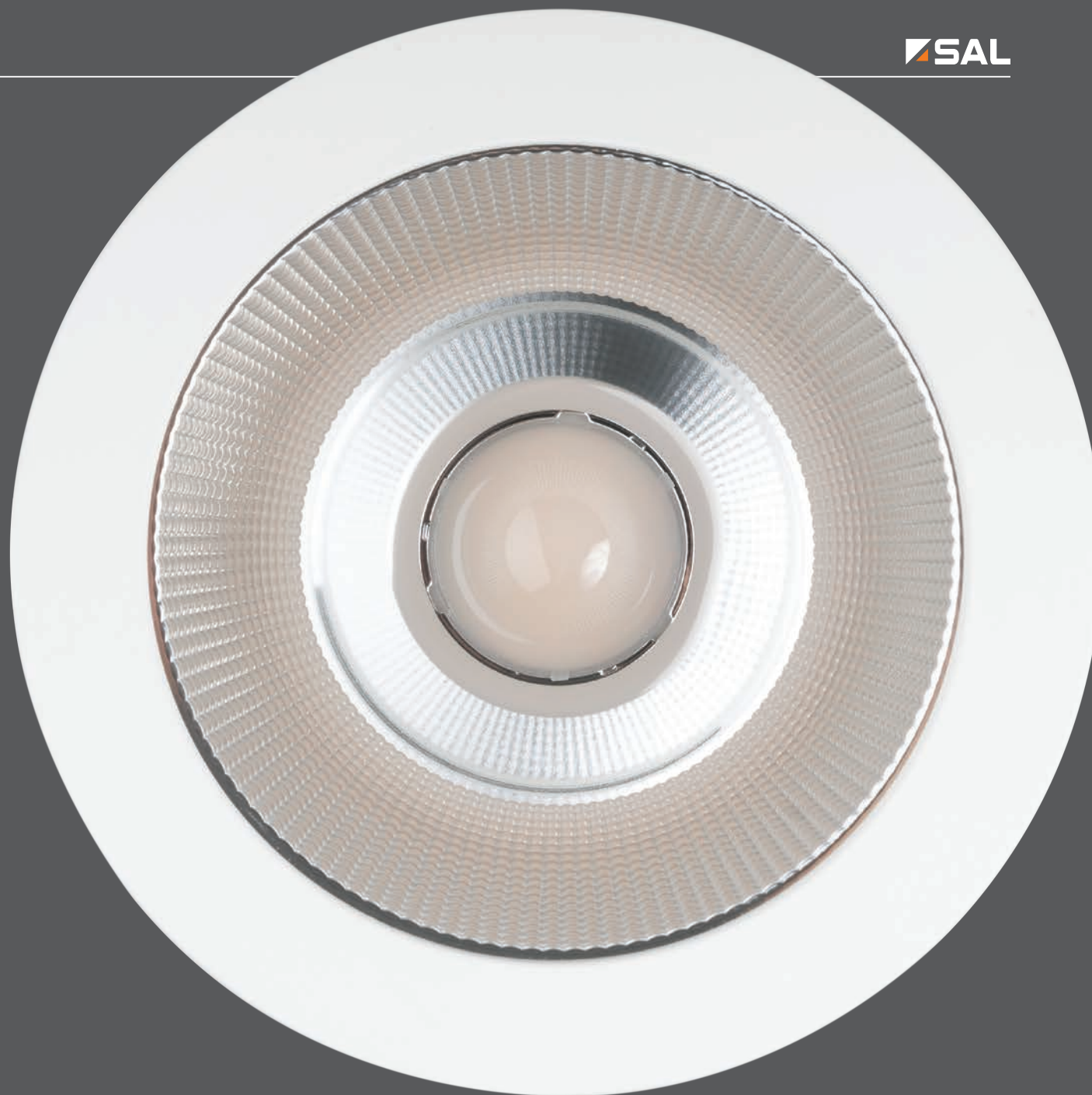



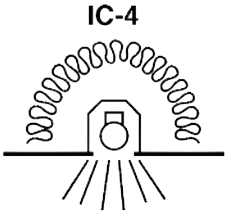

Before selecting a downlight look out for the marks of Compliance and Safety. Starting with the RCM mark, this signals that the product has been tested to all relevant Australian Safety standards, to ensure the product delivers its designed safety performance. In addition and when thermal insulation batts are installed in the ceiling cavity, look out of the IC rating to ensure the product is suitable for such an application.





TC SELECTABLE COLOUR

## ALBANY S9514TC - 28W/36W

Recessed LED rectangular shop light with selectable CCT and power

### Application

Ideal for any retail or commercial interior space

### Design Specifications

- Selectable CCT 3000K / 4000K / 5500K
- Selectable power setting 28W/36W
- Adjustable tilt up to 60°
- Remote non-dimmable LED driver, complete with flex & plug
- Stylish white or silver powder coat finish
- High efficiency LED optics
- Double insulated

### Performance

- Dimmable - Optional, Trailing edge, 1-10V, DALI / DSI



### Technical Specifications

Model No.	Input (V)/(Hz)	Power (W)	Lumen (lm)	CCT (K)	CRI	Beam Angle	Dimmable	Fitting Colour
S9514TC WH	240/50	28/36	2800/3600	3000/4000/5500	> 80	100°	Optional	White
S9514TC SL	240/50	28/36	2800/3600	3000/4000/5500	> 80	100°	Optional	Silver



**Dimensions** L 215 x W 130 mm

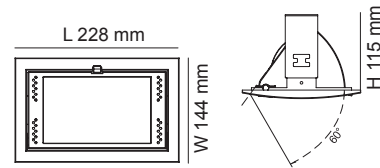

### Photometric Data S9514TC at 3000K

Unit: cd C0/C180 — C90/C270

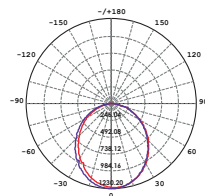

TC SELECTABLE COLOUR

## CLARE S9062TC/S - 10W

Recessed LED downlight with PIR sensor control and selectable CCT

### Application

Ideal for interior service areas, bathrooms and storage spaces

### Design Specifications

- Selectable CCT 3000K / 4000K / 5700K
- Integral PIR sensor control with a fixed 90 second ON motion detection function, incorporating a light sensor function to engage when the lighting levels are <20lux
- Integral non-dimmable LED 10 watt control gear, IC - 4 rated, complete with flex & plug
- Stylish white trim with an opal PC diffuser
- Double insulated

### Performance

- Non-dimmable

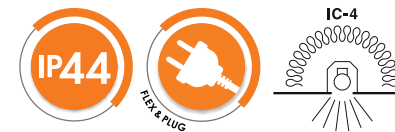

### Technical Specifications

Model No.	Input (V)/(Hz)	Power (W)	Lumen (lm)	CCT (K)	CRI	Beam Angle	Dimmable	Fitting Colour
S9062TC/S	240/50	10	760/800/850	3000/4000/5700	> 80	90°	No	White



**Dimensions** Ø 92 mm

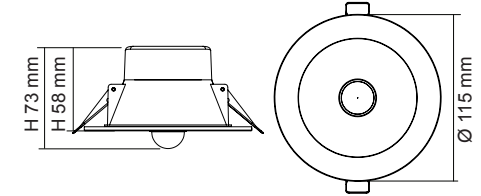

### Photometric Data S9062TC/S at 3000K

Unit: cd C0/C180 — C90/C270

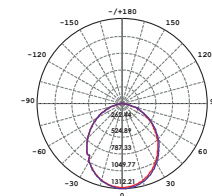

For interior products, the IP rating stated is from below the ceiling

For terms of catalogue data use, refer to INDEX





TC SELECTABLE COLOUR



## COOLUM PLUS S9067TC - 6W

6 watt dimmable LED downlight,  
UGR<19, with selectable CCT

### Application

Ideal for any residential or commercial interior space

### Design Specifications

- 6 watt integral flickerCONTROLLED dimmable driver, complete with flex & plug
- High efficiency LED optics, multi-faceted optical system
- Selectable CCT 3000K / 4000K / 5700K, CRI 80, 60° beam distribution, UGR<19
- Polyamide trim and body in white or black
- IC - 4 rated, double insulated



### Dimensions

Ø 72 mm

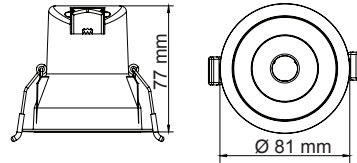

### Photometric Data S9067TC/WH at 4000K

Unit: cd C0/C180 — C30/C210  
C60/C240 — C90/C270

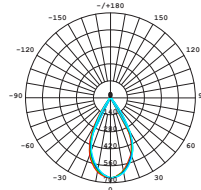

### Performance

- Dimmable, trailing edge



### Technical Specifications

Model No.	Input (V)/(Hz)	Power (W)	Lumen (lm)	CCT (K)	CRI	Beam Angle	Dimmable	Fitting Colour
S9067TC/WH	240/50	6	480/530/510	3000/4000/5700	> 80	60°	Yes	White
S9067TC/BK	240/50	6	420/470/440	3000/4000/5700	> 80	60°	Yes	Black



TC SELECTABLE COLOUR



## COOLUM PLUS S9068TC - 9W

9 watt dimmable LED downlight,  
UGR<19, with selectable CCT

### Application

Ideal for any residential or commercial interior space

### Design Specifications

- 9 watt integral flickerCONTROLLED dimmable driver, complete with flex & plug
- High efficiency LED optics, multi-faceted optical system
- Selectable CCT 3000K / 4000K / 5700K, CRI>80, 60° beam distribution, UGR<19
- Polyamide trim and body in white or black
- IC - 4 rated, double insulated



### Dimensions

Ø 92 mm

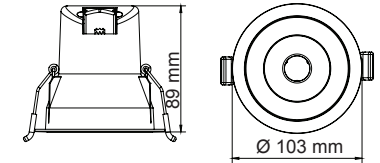

### Photometric Data S9068TC/WH at 4000K

Unit: cd C0/C180 — C30/C210  
C60/C240 — C90/C270

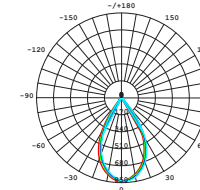

### Performance

- Dimmable, trailing edge



### Technical Specifications

Model No.	Input (V)/(Hz)	Power (W)	Lumen (lm)	CCT (K)	CRI	Beam Angle	Dimmable	Fitting Colour
S9068TC/WH	240/50	9	700/800/750	3000/4000/5700	> 80	60°	Yes	White
S9068TC/BK	240/50	9	570/630/610	3000/4000/5700	> 80	60°	Yes	Black

For interior products, the IP rating stated is from below the ceiling

For terms of catalogue data use, refer to INDEX



sal.net.au



TC SELECTABLE COLOUR



## COOLUM PLUS S9068TC/FG - 9W

9 watt dimmable LED downlight, UGR<19,  
with selectable CCT and flickerGUARD

### Application

Ideal for any residential or commercial interior space, experiencing nuisance harmonic induced flicker

### Design Specifications

- The innovative flickerGUARD Coolum responds to both visual and non-visual harmonic induced flicker.
- Integral flickerGUARD trailing edge dimmable LED driver, with smooth dimming performance and flex and plug
- High efficiency LED optics, multi-faceted optical system, 60° beam distribution, UGR<19
- Selectable CCT 3000K / 4000K / 5700K
- White or black polyamide trim and body
- IC - 4 rated, double insulated



UGR  
<19

### Dimensions

Ø 92 mm

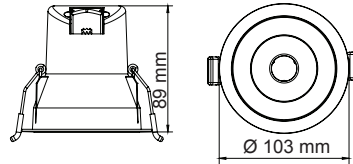

### Photometric Data

S9068TC/WH/FG at 4000K

Unit: cd C0/C180 — C30/C210  
C60/C240 — C90/C270

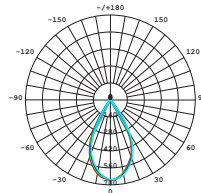

### Performance

- Dimmable, trailing edge



### Technical Specifications

Model No.	Input (V)/(Hz)	Power (W)	Lumen (lm)	CCT (K)	CRI	Beam Angle	Dimmable	Fitting Colour
S9068TC/WH/FG	240/50	9	700/800/750	3000/4000/5700	> 90	60°	Yes	White
S9068TC/BK/FG	240/50	9	570/630/610	3000/4000/5700	> 90	60°	Yes	Black



For interior products, the IP rating stated is from below the ceiling



# FlickerGUARD™ MORE THAN FLICKER CONTROL.

Fed up with LED flicker? The solution is the innovative flickerGUARD™ series from SAL, offering a reliable solution for visual and non-visual harmonic flicker.



Image courtesy of QCE,  
photography Indie Lane Tourquay







TUNABLE WHITE



## COOLUM PLUS S9068TW/RS - 9W

9 watt dimmable LED downlight, UGR<19, with **tunable WHITE** and **rippleSHIELD**

### Application

Ideal for any residential or commercial interior space, experiencing nuisance ripple induced flicker

### Design Specifications

- Combined with the SAL SDD400SFI dimmer, the rippleSHIELD Coolum eliminates ALL nuisance non-visible and visible flicker caused by ripple injection
- Integral 9 watt rippleSHIELD dimmable LED driver, with smooth dimming performance down to 1.0% of light output, designed with flex and plug for easy installation.
- Tunable WHITE from 3000K to 5700K
- High efficiency LED optics, multi-faceted optical system, 60° beam distribution, UGR<19
- Polyamide trim and body, choice of white or black
- IC - 4 rated, double insulated
- Dimmable, only with SDD400SFI dimmer



UGR <19

### Dimensions

Ø 92 mm

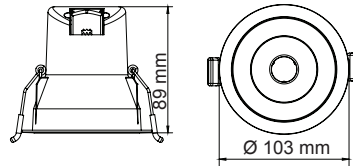

### Photometric Data S9068TW35WH/RS at 4000K

Unit: cd C0/C180 C30/C210  
C60/C240 C90/C270

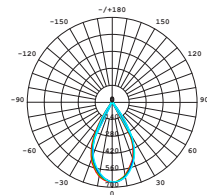

### Performance

- Dimmable, trailing edge



### Technical Specifications

Model No.	Input (V)/(Hz)	Power (W)	Lumen (lm)	CCT (K)	CRI	Beam Angle	Dimmable	Fitting Colour
S9068TW35WH/RS	240/50	9	800 @4000K	3000 - 5700	> 90	60°	Yes	White
S9068TW35BK/RS	240/50	9	630 @4000K	3000 - 5700	> 90	60°	Yes	Black
SDD400SFI	240/50						Yes	Grey

For interior products, the IP rating stated is from below the ceiling



# RIPPLE SHIELD ELIMINATES RIPPLE INDUCED FLICKER.



Sick and tired of your LED downlight nuisance flicker late at night? The simple solution is the SAL Ripple SHIELD™ DIMMER SDD400SFI, combined with SAL Ripple SHIELD™ downlights (Ecogem Ripple SHIELD™ and Unifit Ripple SHIELD™), eliminating nuisance flicker caused by ripple injection once and for all!

## DIM with FLICKER CONTROL



TC SELECTABLE COLOUR



## COOLUM PLUS S9069TC - 12W

12 watt dimmable LED downlight,  
UGR<19, with selectable CCT

### Application

Ideal for any residential or  
commercial interior space

### Design Specifications

- 12 watt integral constant current dimmable driver complete with flex & plug for easy installation
- High efficiency LED optics, multi-faceted optical system
- Selectable CCT 3000K / 4000K / 5700K, CRI>80, 60° beam distribution, UGR<19
- Polyamide trim and body form white or black
- IC - 4 rated, double insulated



UGR  
<19

### Dimensions

Ø 120 mm

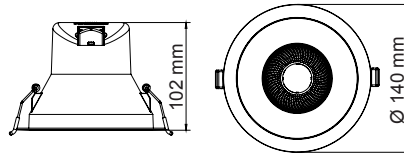

### Performance

- Dimmable, trailing edge



### Photometric Data S9069TC/WH 4000K

Unit: cd C0/C180 — C30/C210  
C60/C240 — C90/C270

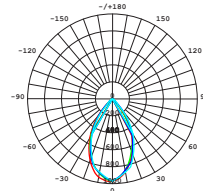

### Technical Specifications

Model No.	Input (V)/(Hz)	Power (W)	Lumen (lm)	CCT (K)	CRI	Beam Angle	Dimmable	Fitting Colour
S9069TC/WH	240/50	12	840/920/900	3000/4000/5700	> 80	60°	Yes	White
S9069TC/BK	240/50	12	680/740/720	3000/4000/5700	> 80	60°	Yes	Black

For interior products, the IP rating stated is from below the ceiling



Image courtesy of





TC SELECTABLE COLOUR



## COOLUM PLUS S9167TC - 6W

6 watt dimmable, LED TILT downlight, with selectable CCT

### Application

Ideal for any residential or commercial interior space

### Design Specifications

- 6 watt integral flickerCONTROLLED dimmable driver, complete with flex & plug for easy installation
- High efficiency LED optics, multi-faceted optical system
- Selectable CCT 3000K / 4000K / 5700K, CRI > 80, 40° beam distribution
- Polyamide trim and body in white or black
- IC - 4 rated, double insulated



Dimensions Ø 72 mm

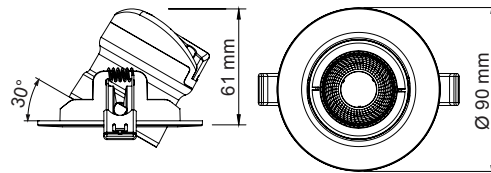

### Performance

- Dimmable, trailing edge



Photometric Data S9167TC at 4000K

Unit: cd C0/C180 C30/C210  
C60/C240 C90/C270

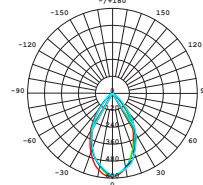

### Technical Specifications

Model No.	Input (V)/(Hz)	Power (W)	Lumen (lm)	CCT (K)	CRI	Beam Angle	Dimmable	Fitting Colour
S9167TC/WH	240/50	6	500/560/540	3000/4000/5700	> 80	40°	Yes	White
S9167TC/BK	240/50	6	500/560/540	3000/4000/5700	> 80	40°	Yes	Black

For interior products, the IP rating stated is from below the ceiling



TC SELECTABLE COLOUR



## COOLUM PLUS S9168TC - 9W

9 watt dimmable, LED TILT downlight, with selectable CCT

### Application

Ideal for any residential or commercial interior space

### Design Specifications

- 9 watt integral flickerCONTROLLED dimmable driver, complete with flex & plug for easy installation
- High efficiency LED optics, multi-faceted optical system
- Selectable CCT 3000K / 4000K / 5700K, CRI > 80, 40° beam distribution
- Polyamide trim and body in white or black
- IC - 4 rated, double insulated



Dimensions Ø 92 mm

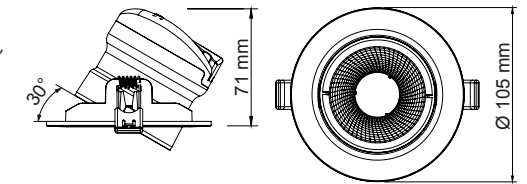

### Performance

- Dimmable, trailing edge



Photometric Data S9168TC at 4000K

Unit: cd C0/C180 C30/C210  
C60/C240 C90/C270

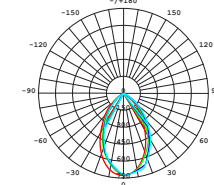

### Technical Specifications

Model No.	Input (V)/(Hz)	Power (W)	Lumen (lm)	CCT (K)	CRI	Beam Angle	Dimmable	Fitting Colour
S9168TC/WH	240/50	9	750/830/810	3000/4000/5700	> 80	40°	Yes	White
S9168TC/BK	240/50	9	750/830/810	3000/4000/5700	> 80	40°	Yes	Black

For terms of catalogue data use, refer to INDEX





TC SELECTABLE COLOUR

## ECO GEM S9041 TC - 10W

Dimmable 10 watt LED downlight, with selectable CCT, IP44

### Application

Ideal for any residential or commercial interior space

### Design Specifications

- Selectable CCT 3000K / 4200K / 5700K
- IC - 4 rated, durable die-cast aluminium body profile
- White powder coat finish or Satin Nickel
- Remote trailing edge dimmable LED driver, with flex and plug
- High efficiency LED optics with an opal polycarbonate diffuser
- White surface mount options available
- Colour trim options: Black (S9041 BK RING), Silver (S9041 SL RING)



Dimensions Ø 92 mm

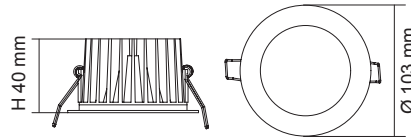

Photometric Data S9041 TC at 3000K

Unit: cd C0/C180 C30/C210 C60/C240 C90/C270

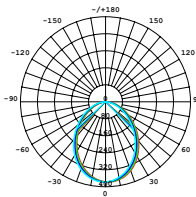

### Performance

- Dimmer Type, Trailing edge
- Dimming Options, 1-10V, DALI / DSI



### Technical Specifications

Model No.	Input (V)/(Hz)	Power (W)	Lumen (lm)	CCT (K)	CRI	Beam Angle	Dimmable	Fitting Colour
S9041 TC WH	240/50	10	850/1000/900	3000/4200/5700	> 80	90°	Yes	White
S9041 TC SN	240/50	10	850/1000/900	3000/4200/5700	> 80	90°	Yes	Satin Nickel

For interior products, the IP rating stated is from below the ceiling



TC SELECTABLE COLOUR

## ECO GEM S9041SM/TC - 10W

Surface mount dimmable LED downlight with selectable CCT

### Application

Ideal for any surface mount, residential or commercial interior space design



### Design Specifications

- Selectable CCT 3000K / 4200K / 5700K
- Precise pressed metal surface mount profile
- White powder coat finish
- SAL S9041TC LED downlight kit included
- High efficiency LED optics with an opal polycarbonate diffuser
- IP20

### Dimensions

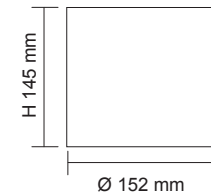

### Performance

- Dimmer Type, Trailing edge
- Dimming Options, 1-10V, DALI / DSI



Photometric Data S9041SM/C TC at 3000K

Unit: cd C0/C180 C30/C210 C60/C240 C90/C270

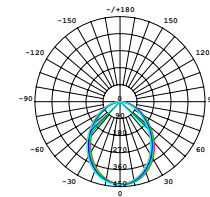

### Technical Specifications

Model No.	Input (V)/(Hz)	Power (W)	Lumen (lm)	CCT (K)	CRI	Beam Angle	Dimmable	Fitting Colour
S9041SM/TC/WH	240/50	10	850/1000/900	3000/4200/5700	> 80	90°	Yes	White

For terms of catalogue data use, refer to INDEX





TC SELECTABLE COLOUR

## ECOGEM S9041 TC SQUARE - 10W

Dimmable 10 watt LED downlight with selectable CCT, IP44.

### Application

Ideal for any residential or commercial interior space

### Design Specifications

- Selectable CCT 3000K / 4200K / 5700K
- Durable die-cast aluminium square body profile, IC-4 rated
- Trim colour choice of white or satin nickel
- Remote constant current trailing edge dimmable LED driver, with flex and plug
- High efficiency LED optics, opal polycarbonate diffuser.
- High performance, HO 13W model available



### Dimensions

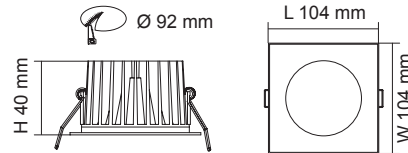

### Photometric Data S9041 TC at 3000K

Unit: cd C0/C180 — C30/C210  
C60/C240 — C90/C270

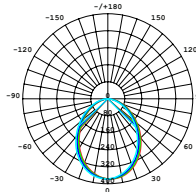

### Performance

- Dimmer Type, Trailing edge
- Dimming Options, 1-10V, DALI / DSI



### Technical Specifications

Model No.	Input (V)/(Hz)	Power (W)	Lumen (lm)	CCT (K)	CRI	Beam Angle	Dimmable	Fitting Colour
S9041 TC S WH	240/50	10	800/900/850	3000/4200/5700	> 80	90°	Yes	White
S9041 TC S SN	240/50	10	800/900/850	3000/4200/5700	> 80	90°	Yes	Satin Nickel



TC SELECTABLE COLOUR

## ECOGEM S9041TC2 - 10W

Dimmable 10 watt LED downlight, with selectable CCT, IP44.

### Application

Ideal for any residential or commercial interior space

### Design Specifications

- Selectable CCT 3000K/4200K/5700K
- Durable Polyamide, reinforced aluminium body profile, white trim
- Trailing edge dimmable LED driver, with flex and plug
- High efficiency LED optics with an opal polycarbonate diffuser
- White surface mount options available, 145hm, x Ø152mm (S9041SM/TC2WH)
- Colour trim options: Black (S9041 BK RING), Silver (S9041 SL RING), Satin Nickel (S9041 SN RING)
- IC - 4 rated, double insulated



### Dimensions

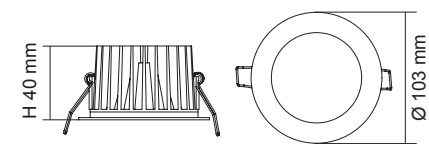

### Photometric Data S9041TC2WH at 3000K

Unit: cd C0/C180 — C30/C210  
C60/C240 — C90/C270

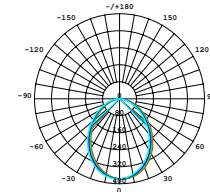

### Performance

- Dimmer Type, Trailing edge



### Technical Specifications

Model No.	Input (V)/(Hz)	Power (W)	Lumen (lm)	CCT (K)	CRI	Beam Angle	Dimmable	Fitting Colour
S9041TC2WH	240/50	10	850/1000/900	3000/4200/5700	> 80	90°	Yes	White
S9041SM/TC2WH	240/50	10	850/1000/900	3000/4200/5700	> 80	90°	Yes	White

For interior products, the IP rating stated is from below the ceiling

For terms of catalogue data use, refer to INDEX





TC SELECTABLE COLOUR



## ECOGEM S9041TC2 FG - 10W

Dimmable 10 watt LED downlight with selectable CCT and flickerGUARD

### Application

Ideal for any residential or commercial interior space, experiencing nuisance harmonic induced flicker

### Design Specifications

- The innovative flickerGUARD Ecogem responds to both visual and non-visual harmonic induced flicker.
- Trailing edge dimmable LED driver, with smooth dimming performance and flex and plug
- High efficiency LED optics with an opal polycarbonate diffuser
- Selectable CCT 3000K / 4200K / 5700K
- Durable Polyamide, reinforced aluminium body profile and white trim.
- Colour trim options: Black (S9041 BK RING), Silver (S9041 SL RING), Satin Nickel (S9041 SN RING)
- IC - 4 rated, double insulated



Dimensions Ø 92 mm

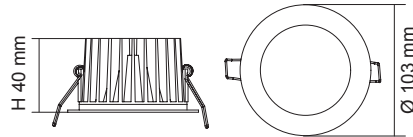

Photometric Data S9041TC2WH/FG at 4000K

Unit: cd C0/C180 — C30/C210  
C60/C240 — C90/C270

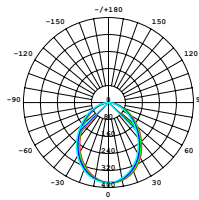

### Performance

- Dimmable, trailing edge



### Technical Specifications

Model No.	Input (V)/(Hz)	Power (W)	Lumen (lm)	CCT (K)	CRI	Beam Angle	Dimmable	Fitting Colour
S9041TC2WH/FG	240/50	10	850/1000/900	3000/4200/5700	> 90	90°	Yes	White



For interior products, the IP rating stated is from below the ceiling



# FlickerGUARD™ MORE THAN FLICKER CONTROL.

Fed up with LED flicker? The solution is the innovative flickerGUARD™ series from SAL, offering a reliable solution for visual and non-visual harmonic flicker.



TC SELECTABLE COLOUR



## ECOGEM S9041TC RS - 10W

Dimmable 10 watt LED downlight with selectable CCT and rippleSHIELD

### Application

Ideal for any residential or commercial interior space, experiencing nuisance ripple induced flicker

### Design Specifications

- Combined with the SAL SDD400SFI dimmer, the rippleSHIELD Coolum eliminates ALL nuisance non-visible and visible flicker caused by ripple injection
- Remote rippleSHIELD dimmable LED driver, with smooth dimming performance down to 1.0% of light output, designed with flex and plug
- Selectable CCT 3000K / 4200K / 5700K
- Stylish white powder coat finish colour trim options: (S9041 BK RING), (S9041 SN RING), (S9041 SL RING).
- IC - 4 rated, double insulated



Dimensions  Ø 92 mm

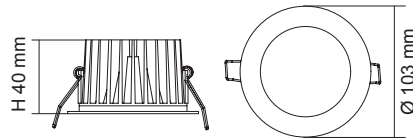

### Photometric Data S9041TC/WH/SFI at 4000K

Unit: cd C0/C180 C30/C210  
C60/C240 C90/C270

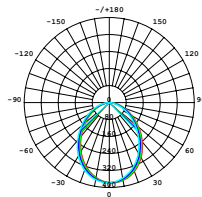

### Performance

- Dimmable, only with SAL rippleSHIELD SDD400SFI



### Technical Specifications

Model No.	Input (V)/(Hz)	Power (W)	Lumen (lm)	CCT (K)	CRI	Beam Angle	Dimmable	Fitting Colour
S9041TC/WH/SFI	240/50	10	850/1000/900	3000/4200/5700	> 80	90°	Yes	White
SDD400SFI	240/50						Yes	Grey

For interior products, the IP rating stated is from below the ceiling



# RIPPLE SHIELD ELIMINATES RIPPLE INDUCED FLICKER.



Sick and tired of your LED downlight nuisance flicker late at night? The simple solution is the SAL Ripple SHIELD™ DIMMER SDD400SFI, combined with SAL Ripple SHIELD™ downlights (Ecogem Ripple SHIELD™ and Unifit Ripple SHIELD™), eliminating nuisance flicker caused by ripple injection once and for all!

**DIM with FLICKER CONTROL**



**SAL**

TC SELECTABLE COLOUR

## ECOGEM S9041HO/TC - 13W

High output dimmable 13 watt LED downlight, with selectable CCT, IP44

### Application

Ideal for any residential or commercial interior space

### Design Specifications

- Selectable CCT 3000K / 4200K / 5700K
- Durable die-cast aluminium body profile
- Stylish white powder coat finish
- Remote, trailing edge dimmable LED driver, with flex and plug
- High efficiency LED optics with an opal polycarbonate diffuser
- White surface mount options available, 145hm, x Ø152mm (S9041HO/SM/TC/WH)
- Colour trim options: Black (S9041 BK RING), Silver (S9041 SL RING), Satin Nickel (S9041 SN RING)
- IC - 4 rated, double insulated



**Dimensions** Ø 92 mm

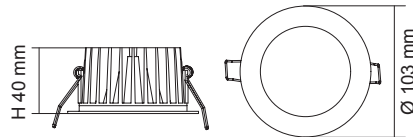

### Performance

- Dimmer Type, Trailing edge
- Dimming Options, 1-10V, DALI / DSI



### Photometric Data S9041HO/TC at 3000K

Unit: cd C0/C180 — C30/C210  
C60/C240 — C90/C270

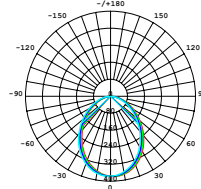

### Technical Specifications

Model No.	Input (V)/(Hz)	Power (W)	Lumen (lm)	CCT (K)	CRI	Beam Angle	Dimmable	Fitting Colour
S9041HO/TC/WH	240/50	13	1040/1170/1105	3000/4200/5700	> 80	90°	Yes	White
S9041HO/SM/TC/WH	240/50	13	1040/1170/1105	3000/4200/5700	> 80	90°	Yes	White



**SAL**

TC SELECTABLE COLOUR

## ECOSTAR S9048TC - 12W

Dimmable 12 watt LED downlight, with selectable CCT, IP54.

### Application

Ideal for any residential or commercial interior space

### Design Specifications

- Selectable CCT 3000K / 4000K / 5000K
- Durable die-cast aluminium body profile
- Stylish powder coat or plated finish
- High output LED optics
- Multi-faceted reflector, 55° beam
- Remote, trailing edge dimmable LED driver, with flex and plug
- White surface mount options available, 145hm, x Ø152mm (S9048SM/TC/WH)
- IC - 4 rated, double insulated



**Dimensions** Ø 92 mm

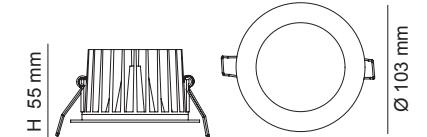

### Performance

- Dimmer Type, Trailing edge
- Dimming Options, 1-10V, DALI / DSI



### Photometric Data S9048TC/WH at 3000K

Unit: cd C0/C180 — C90/C270

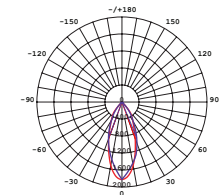

### Technical Specifications

Model No.	Input (V)/(Hz)	Power (W)	Lumen (lm)	CCT (K)	CRI	Beam Angle	Dimmable	Fitting Colour
S9048TC/WH	240/50	12	1000/1200/1100	3000/4000/5000	> 80	55°	Yes	White
S9048SM/TC/WH	240/50	12	1000/1200/1100	3000/4000/5000	> 80	55°	Yes	White

For interior products, the IP rating stated is from below the ceiling

For terms of catalogue data use, refer to INDEX







TC SELECTABLE COLOUR

## ECOSTAR S9045TC - 9W

Dimmable 9 watt **FIXED** LED downlight, with selectable CCT.

### Application

Ideal for any residential or commercial interior space

### Design Specifications

- Durable die-cast aluminium body profile
- Stylish white powder coat or satin nickel
- High output LED optics, CRI>80
- Selectable CCT 3000K/4000K/5700K
- Remote, trailing edge, dimmable LED driver, with flex and plug
- IC - 4 rated, double insulated



Dimensions Ø 72 mm

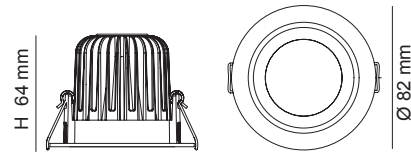

### Performance

- Dimmable, Trailing edge
- Dimming Options, 1-10V, DALI / DSI



### Photometric Data S9045TC/WH at 3000K

Unit: cd C0/C180 — C90/C270

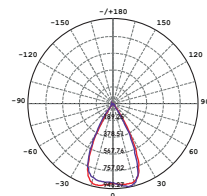

### Technical Specifications

Model No.	Input (V)/(Hz)	Power (W)	Lumen (lm)	CCT (K)	CRI	Beam Angle	Dimmable	Fitting Colour
S9045TC/WH	240/50	9	800/800/850	3000/4000/5700	> 80	60°	Yes	White
S9045TC/SN	240/50	9	800/800/850	3000/4000/5700	> 80	60°	Yes	Satin Nickel



TC SELECTABLE COLOUR

## ECOSTAR S9046TC - 9W

Dimmable 9 watt **GIMBAL** LED downlight, with selectable CCT.

### Application

Ideal for any residential or commercial interior space

### Design Specifications

- Durable die-cast aluminium body profile
- Stylish white powder coat or satin nickel
- Versatile gimbal head with 30° tilt
- High output LED optics, CRI > 80
- Selectable CCT 3000K/4000K/5700K
- Remote, trailing edge, dimmable LED driver with flex and plug
- White surface mount options available, 145hm, x Ø152mm (S9046SM/TC/WH)
- IC - 4 rated, double insulated



Dimensions Ø 92 mm

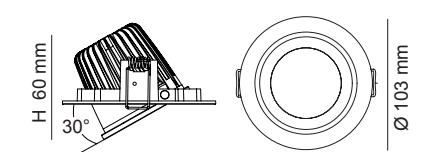

### Performance

- Dimmable, Trailing edge
- Dimming Options, 1-10V, DALI / DSI



### Photometric Data S9046TC at 3000K

Unit: cd C0/C180 — C90/C270

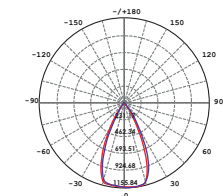

### Technical Specifications

Model No.	Input (V)/(Hz)	Power (W)	Lumen (lm)	CCT (K)	CRI	Beam Angle	Dimmable	Fitting Colour
S9046TC/WH	240/50	9	800/800/850	3000/4000/5700	> 80	60°	Yes	White
S9046TC/SN	240/50	9	800/800/850	3000/4000/5700	> 80	60°	Yes	Satin Nickel
S9046SM/TC/WH	240/50	9	800/800/850	3000/4000/5700	> 80	60°	Yes	White

For interior products, the IP rating stated is from below the ceiling

For terms of catalogue data use, refer to INDEX



# SMARTER LIGHTING CHOICES



<b>BENTO S9691 SQUARE PROFILE IP44 LED DOWNLIGHT.</b> PRODUCT INFO GUIDE	<b>BLADE LED BATTEN SL9707TC LOW PROFILE WIDE BODY</b> PRODUCT INFO GUIDE 35W	<b>BLADE LED BATTEN SL9709TC LOW PROFILE WIDE BODY</b> PRODUCT INFO GUIDE 50W	<b>BRIGHTSTAR ECO SE7199 LED FLOODLIGHTS</b> PRODUCT INFO GUIDE	<b>THE VERSATILE CANOPY LED SHP205</b> PRODUCT INFO GUIDE
<b>COOPER III</b> PRODUCT INFO GUIDE	<b>COOLUM PLUS S9167TC.</b> PRODUCT INFO GUIDE	<b>COOPER II</b> PRODUCT INFO GUIDE	<b>ECOLINE XV SL9731TC/DP</b> PRODUCT INFO GUIDE	<b>ECOLINE SL9738 LED WIDE DIFFUSED BATTEN</b> PRODUCT INFO GUIDE
<b>EMERGENCY EXIT SELK1500EX2</b> PRODUCT INFO GUIDE	<b>THE NEW QUICK CONNECT ESS107</b> PRODUCT INFO GUIDE	<b>STREAMLINE LOW PROFILE FRISSE SL2104TC</b> PRODUCT INFO GUIDE	<b>THE NEW GIBALTAR SL9722TC LED VANDALPROOF BATTEN</b> PRODUCT INFO GUIDE	<b>REMARK D LED DOWNLIGHTS</b> PRODUCT INFO GUIDE
<b>COOLUM PLUS S9168TC.</b> PRODUCT INFO GUIDE	<b>SLIMLINE SEAMLESS TC LINKABLE SL9706</b> PRODUCT INFO GUIDE	<b>PIXIE AMBIENCE SMART SOCKET</b> PRODUCT INFO GUIDE	<b>STARPAD II SE7071 TC FLOODLIGHT</b> PRODUCT INFO GUIDE	<b>THE NEW UFO SHB25MP150TC LED HIGHBAY</b> PRODUCT INFO GUIDE
<b>WAVE SE S9063TC LED DOWNLIGHT</b> PRODUCT INFO GUIDE	<b>WIDELINE SL9733TC/DP</b> PRODUCT INFO GUIDE	<b>BISMARCK II S9794 LED PANEL</b> PRODUCT INFO GUIDE	<b>UFO SHB23SE HIGH BAY</b> PRODUCT INFO GUIDE	<b>COOLUM PLUS S9069TC.</b> PRODUCT INFO GUIDE
<b>ALTONA SQUARE OR ROUND LED WALL LUMINAIRES.</b> PRODUCT INFO GUIDE	<b>BRIGHT STAR LED FLOODLIGHT SE7199</b> PRODUCT INFO GUIDE	<b>BUNKER 15 TC ROUND</b> PRODUCT INFO GUIDE	<b>BUNKER 15 TC OVAL</b> PRODUCT INFO GUIDE	

Scan me

# SAL YouTube PRODUCT GUIDES, MORE INFORMATION, EASY TO FIND



TC SELECTABLE COLOUR

## ECOSTAR II GIMBAL S9146TC2 - 10W

Dimmable, GIMBAL 10 watt LED downlight with selectable CCT.

### Application

Ideal for any residential or commercial interior space

### Design Specifications

- Durable die-cast aluminium body profile 30° gimbal
- Stylish white powder coat finish
- High output LED optics
- Multi-faceted reflector system, 60° beam distribution
- Polycarbonate optical lens
- Remote, trailing edge dimmable LED driver, with flex and plug
- Double insulated
- White surface mount options available, 145hm, x Ø152mm (S9146SM/TC2WH)



Dimensions  Ø 92 mm

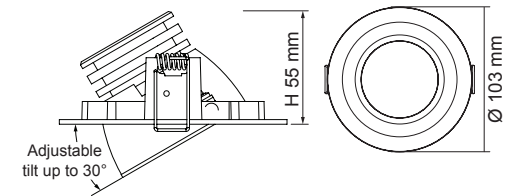

### Performance

- Dimmable, Trailing edge
- Dimming Options, 1-10V, DALI / DSI

### Photometric Data S9146TC2 at 3000K

Unit: cd C0/C180 — C90/C270 —

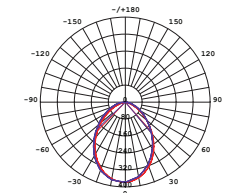

### Technical Specifications

Model No.	Input (V)/(Hz)	Power (W)	Lumen (lm)	CCT (K)	CRI	Beam Angle	Dimmable	Fitting Colour
S9146TC2WH	240/50	10	750/900/850	3000/4000/6000	> 80	60°	Yes	White
S9146SM/TC2WH	240/50	10	750/900/850	3000/4000/6000	> 80	60°	Yes	White

For terms of catalogue data use, refer to INDEX



sal.net.au



TC SELECTABLE COLOUR  
DUAL POWER

## EXMOUTH S9522TC - 15W/22W

Recessed 15/22 watt LED circular shop light with selectable CCT and power

### Application

Ideal for any retail or commercial interior space

### Design Specifications

- Selectable CCT 3000K / 4000K / 5500K
- Selectable power 15W/22W
- Durable die-cast aluminium body profile, with white or silver trim
- Remote, non-dimmable LED driver, with flex and plug
- High efficiency LED optics with an opal polycarbonate diffuser
- IC - 4 rated, double insulated

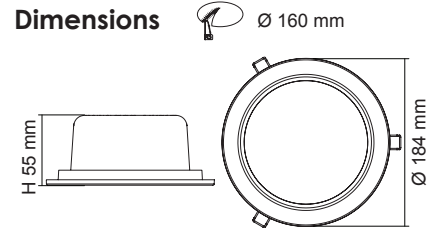

### Performance

- Dimmable - Optional, Trailing edge, 1-10V, DALI / DSI



### Photometric Data S9522TC at 3000K

Unit: cd C0/C180 — C90/C270

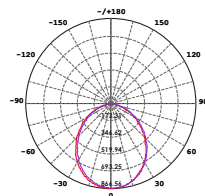

### Technical Specifications

Model No.	Input (V)/(Hz)	Power (W)	Lumen (lm)	CCT (K)	CRI	Beam Angle	Dimmable	Fitting Colour
S9522TC WH	240/50	15/22	1500/2100	3000/4000/5500	> 80	105°	Optional	White
S9522TC SL	240/50	15/22	1500/2100	3000/4000/5500	> 80	105°	Optional	Silver



TC SELECTABLE COLOUR  
DUAL POWER

## EXMOUTH S9523TC - 28W/40W

Recessed 28/40 watt LED circular shop light with selectable CCT and power

### Application

Ideal for any retail or commercial interior space

### Design Specifications

- Selectable CCT 3000K / 4000K / 5500K
- Selectable power 28W/40W
- Durable die-cast aluminium body profile, with white or silver trim
- Remote, non-dimmable LED driver, with flex and plug
- High efficiency LED optics with an opal polycarbonate diffuser
- IC - 4 rated, double insulated
- IP20 surface mount options available 160mm x Ø 240mm (S9523SM/TC/WH)

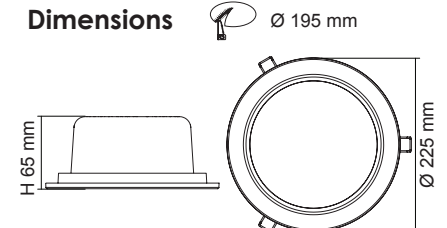

### Performance

- Dimmable - Optional, Trailing edge, 1-10V, DALI / DSI



### Photometric Data S9523TC at 3000K

Unit: cd C0/C180 — C90/C270

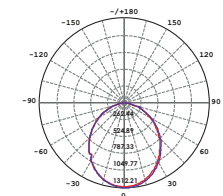

### Technical Specifications

Model No.	Input (V)/(Hz)	Power (W)	Lumen (lm)	CCT (K)	CRI	Beam Angle	Dimmable	Fitting Colour
S9523TC WH	240/50	28/40	2800/3800	3000/4000/5500	> 80	105°	Optional	White
S9523TC SL	240/50	28/40	2800/3800	3000/4000/5500	> 80	105°	Optional	Silver
S9523SM/TC/WH	240/50	28/40	2800/3800	3000/4000/5500	> 80	105°	Optional	White

For interior products, the IP rating stated is from below the ceiling

For terms of catalogue data use, refer to INDEX



sal.net.au



## NEWMAN III S9525 - 15W/25W/35W

Retractable & rotatable LED Shoplight

### Application

Ideal for any retail or commercial interior space

### Design Specifications

- Durable die-cast aluminium body profile
- Stylish white powder coat finish
- Optimum tilting function 60° (-15° ~ +45°) and rotating 340°
- High output LED optics, 24° / 40° standard beam (refer model no.), optional 24°, 38°, 60°
- High performance optical lens with a changeable multi-faceted reflector system
- Remote, non-dimmable LED driver, with flex and plug
- Double insulated



### Dimensions

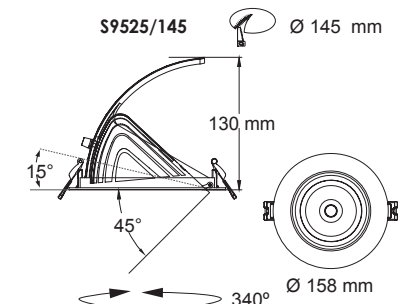
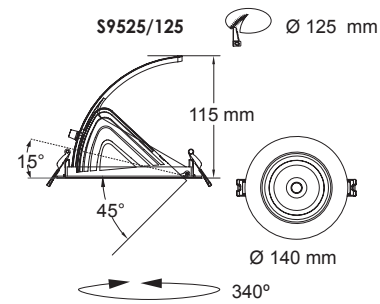
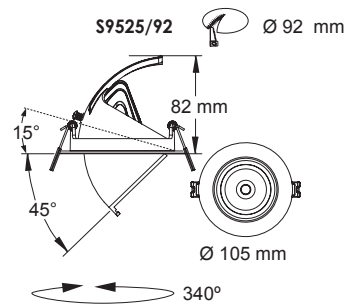

### Performance

- Dimmable - Optional, Refer model No., Trailing edge, 1-10V, DALI / DSI



### Photometric Data

Unit: cd C0/C180 — C90/C270

S9525/92WW/WH at 3000K S9525/145WW/WH at 3000K

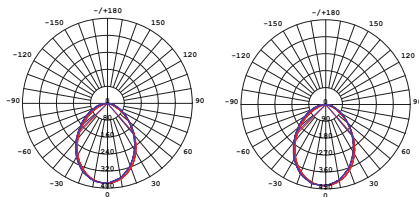

For interior products, the IP rating stated is from below the ceiling



### Technical Specifications

Model No.	Input (V)/(Hz)	Power (W)	Lumen (lm)	CCT (K)	CRI	Beam Angle	Dimmable	Fitting Colour
S9525/92WW/WH	240/50	15	1300	3000	> 80	40°	Yes	White
S9525/92CW/WH	240/50	15	1400	4000	> 80	40°	Yes	White
S9525/92DL/WH	240/50	15	1500	5700	> 80	40°	Yes	White
S9525/125WW/WH	240/50	25	1900	3000	> 80	24°	Optional	White
S9525/125CW/WH	240/50	25	2000	4000	> 80	24°	Optional	White
S9525/125DL/WH	240/50	25	2100	5700	> 80	24°	Optional	White
S9525/145WW/WH	240/50	35	2600	3000	> 80	40°	Optional	White
S9525/145CW/WH	240/50	35	2700	4000	> 80	40°	Optional	White
S9525/145DL/WH	240/50	35	2800	5700	> 80	40°	Optional	White

For terms of catalogue data use, refer to INDEX





TC SELECTABLE COLOUR  
DUAL POWER

## NEWMAN MKIII S9545TC DP2 - 28W/38W

Rotatable & retractable LED Spotlight  
with selectable CCT and power

### Application

Ideal for any retail or  
commercial interior space

### Design Specifications

- Durable die-cast aluminium body profile, with white trim
- Selectable CCT 3000K / 4000K / 5700K
- Selectable power 28W/38W
- Opal PMMA diffuser
- High efficiency LED optics, 90° reflector system
- Remote, non-dimmable, dual power LED driver, with flex and plug
- Double insulated



### Dimensions

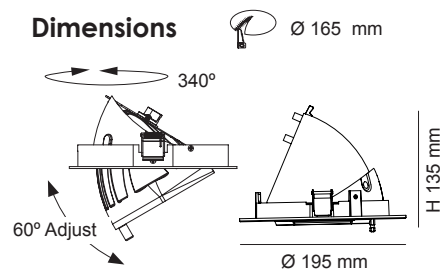

### Performance

- Dimmable - Optional, Trailing edge, 1-10V, DALI / DSI



### Photometric Data S9545TC/WH/DP2 at 3000K

Unit: cd C0/C180 — C90/C270

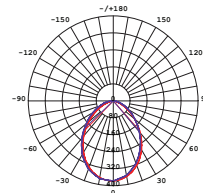

### Technical Specifications

Model No.	Input (V)/(Hz)	Power (W)	Lumen (lm)	CCT (K)	CRI	Beam Angle	Dimmable	Fitting Colour
S9545TC/WH/DP2	240/50	28 38	2100/2400/2200 2600/3200/2800	3000/4000/5700	> 80	90°	Optional	White



For interior products, the IP rating stated is from below the ceiling

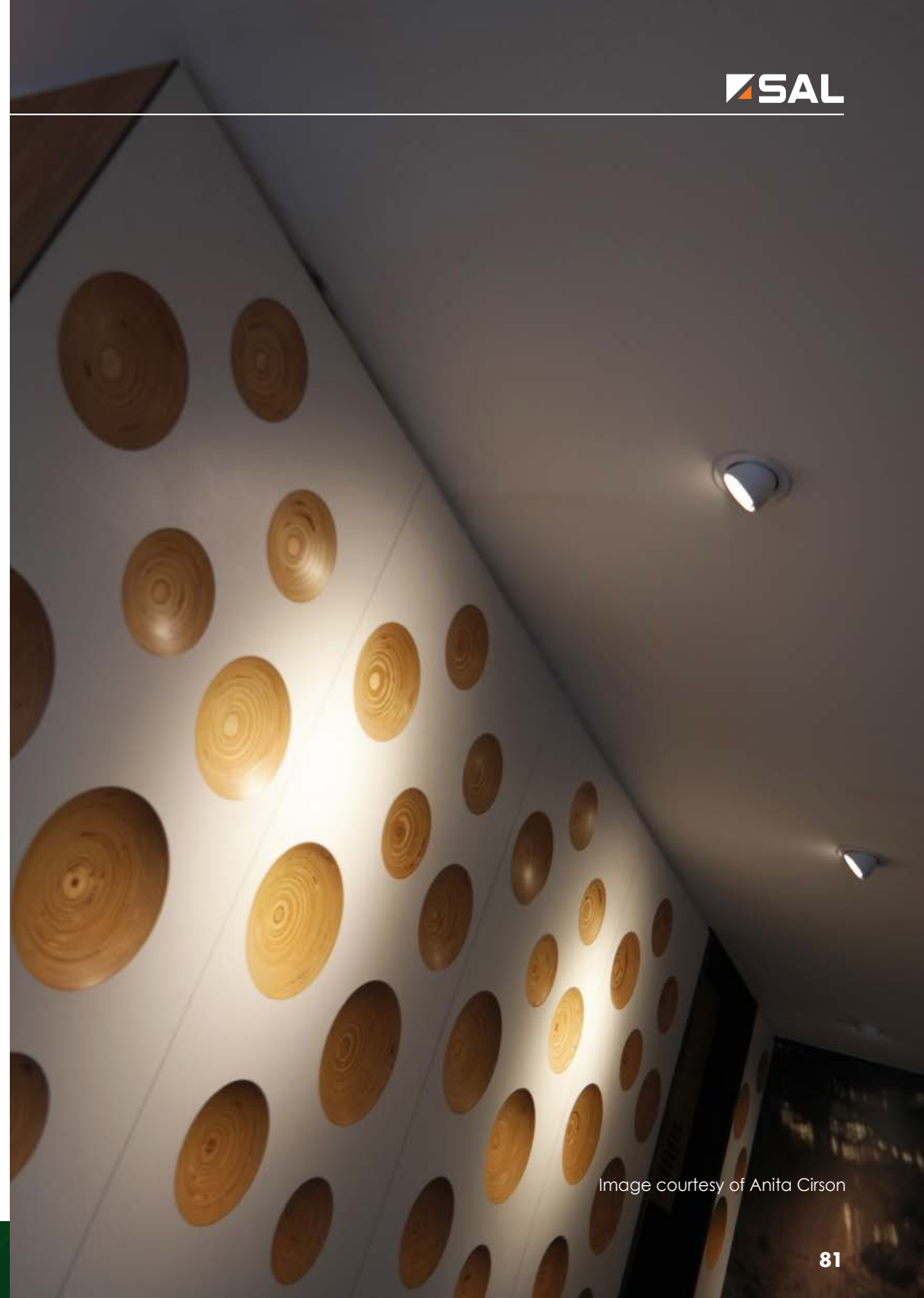

Image courtesy of Anita Cirson



TC SELECTABLE COLOUR

## PREMIER S9071TC - 10W

Dimmable 10 watt LED downlight with selectable CCT, IP64

### Application

Ideal for any residential or commercial interior space

### Design Specifications

- Selectable CCT 3000K / 4000K / 5700K
- Premium aluminium body profile
- Stylish white or silver trim
- Recessed opal polycarbonate diffuser
- High efficiency LED optics
- Remote, trailing edge dimmable LED driver, with flex and plug
- IC - 4 rated, double insulated

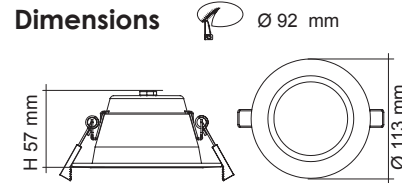

### Performance

- Dimmable, Trailing edge
- Dimming Options, 1-10V, DALI / DSI



### Photometric Data S9071TC at 3000K

Unit: cd C0/C180 — C90/C270

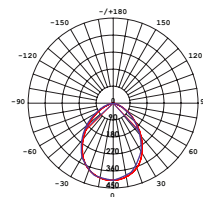

### Technical Specifications

Model No.	Input (V)/(Hz)	Power (W)	Lumen (lm)	CCT (K)	CRI	Beam Angle	Dimmable	Fitting Colour
S9071TC WH	240/50	10	800/900/900	3000/4000/5700	> 80	90°	Yes	White
S9071TC SL	240/50	10	800/900/900	3000/4000/5700	> 80	90°	Yes	Silver

For interior products, the IP rating stated is from below the ceiling



TC SELECTABLE COLOUR

## PREMIER S9072TC - 14W

Dimmable 14 watt LED downlight with selectable CCT, IP64.

### Application

Ideal for any residential or commercial interior space

### Design Specifications

- Selectable CCT 3000K / 4000K / 5700K
- Premium aluminium body profile
- Stylish white or silver trim
- Recessed opal polycarbonate diffuser
- High efficiency LED optics
- Remote, trailing edge dimmable LED driver, with flex and plug
- IC - 4 rated, double insulated

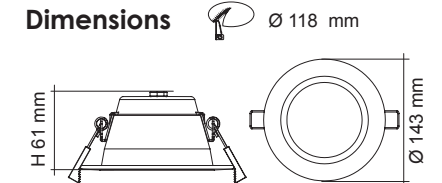

### Performance

- Dimmable, Trailing edge
- Dimming Options, 1-10V, DALI / DSI



### Photometric Data S9072TC at 3000K

Unit: cd C0/C180 — C90/C270

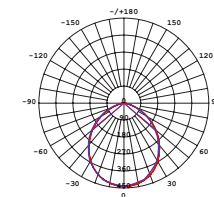

### Technical Specifications

Model No.	Input (V)/(Hz)	Power (W)	Lumen (lm)	CCT (K)	CRI	Beam Angle	Dimmable	Fitting Colour
S9072TC WH	240/50	14	1000/1150/1150	3000/4000/5700	> 80	90°	Yes	White
S9072TC SL	240/50	14	1000/1150/1150	3000/4000/5700	> 80	90°	Yes	Silver

For terms of catalogue data use, refer to INDEX





TC SELECTABLE COLOUR  
DUAL POWER

## PREMIER S9073TC DP - 13W/18W

Dimmable 13/18 watt LED downlight with selectable CCT and power, IP64

### Application

Ideal for any residential or commercial interior space

### Design Specifications

- Selectable CCT 3000K / 4000K / 5700K
- Premium aluminium body, IC-4 rated
- Stylish white or silver trim
- Recessed opal polycarbonate diffuser
- High efficiency LED optics
- Remote, trailing edge dimmable, dual power, LED driver, with flex and plug
- Double insulated



Dimensions  Ø 135 mm

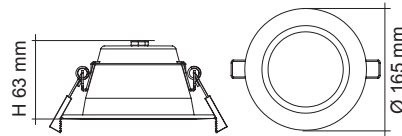

### Performance

- Dimmable, Trailing edge
- Dimming Options, 1-10V, DALI / DSI



### Photometric Data S9073TC/WH/DP at 3000K

Unit: cd C0/C180 — C90/C270

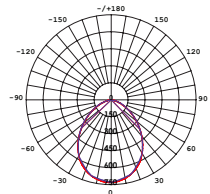

### Technical Specifications

Model No.	Input (V)/(Hz)	Power (W)	Lumen (lm)	CCT (K)	CRI	Beam Angle	Dimmable	Fitting Colour
S9073TC/WH/DP	240/50	13 18	1100/1300/1100 1500/1800/1600	3000/4000/5700	> 80	90°	Yes	White
S9073TC/SL/DP	240/50	13 18	1100/1300/1100 1500/1800/1600	3000/4000/5700	> 80	90°	Yes	Silver



Blackwattle Bay NSW

Images courtesy of MKGS Construction & Paton Power



For interior products, the IP rating stated is from below the ceiling



TC SELECTABLE COLOUR  
DUAL POWER

## PREMIER S9074TC DP/HP - 10W/20W

10/20 watt LED downlight with selectable CCT and power, IP64

### Application

Ideal for any residential or commercial interior space

### Design Specifications

- Premium aluminium body, IC-4 rated
- Selectable CCT 3000K / 4000K / 5700K
- Stylish white trim
- Recessed opal polycarbonate diffuser
- High efficiency LED optics
- (S9074DP) remote, non-dimmable, dual power LED driver, with flex and plug
- (S9074HP) trailing edge dimmable driver
- Double insulated

### Performance

- Dimmable - Refer model No.
- Dimmer Type, Trailing edge
- Dimming Options, 1-10V, DALI / DSI

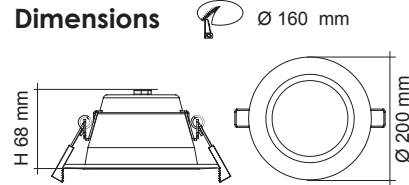
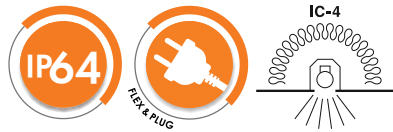

### Photometric Data S9074TC/WH/DP at 3000K

Unit: cd C0/C180 — C90/C270

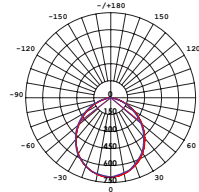

### Technical Specifications

Model No.	Input (V)/(Hz)	Power (W)	Lumen (lm)	CCT (K)	CRI	Beam Angle	Dimmable	Fitting Colour
S9074TC/WH/HP	240/50	10	1000/1100/1000	3000/4000/5700	> 80	90°	Yes	White
S9074TC/WH/DP	240/50	15 20	1200/1400/1300 1600/1900/1700	3000/4000/5700	> 80	90°	Optional	White



TC SELECTABLE COLOUR  
DUAL POWER

## PREMIER S9075TC DP/HP - 12W/30W

12/30 watt LED downlight with selectable CCT and power, IP64

### Application

Ideal for any residential or commercial interior space

### Design Specifications

- Premium aluminium body, IC-4 rated
- Selectable CCT 3000K / 4000K / 5700K
- Stylish white trim
- Recessed opal polycarbonate diffuser
- High efficiency LED optics
- (S9075DP) remote, non-dimmable, dual power LED driver, with flex and plug
- (S9075HP) trailing edge dimmable driver
- Double insulated

### Performance

- Dimmable - Refer model No.
- Dimmer Type, Trailing edge
- Dimming Options, 1-10V, DALI / DSI

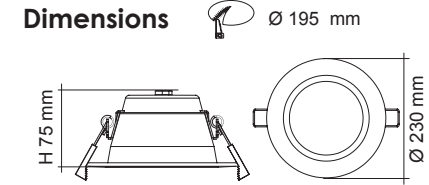

### Photometric Data S9075TC/WH/DP at 3000K

Unit: cd C0/C180 — C90/C270

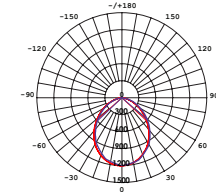

### Technical Specifications

Model No.	Input (V)/(Hz)	Power (W)	Lumen (lm)	CCT (K)	CRI	Beam Angle	Dimmable	Fitting Colour
S9075TC/WH/HP	240/50	12	1300/1400/1400	3000/4000/5700	> 80	90°	Yes	White
S9075TC/WH/DP	240/50	23 30	2000/2300/2100 2600/3100/2800	3000/4000/5700	> 80	90°	Optional	White



For interior products, the IP rating stated is from below the ceiling

For terms of catalogue data use, refer to INDEX



sal.net.au

87

86





TC SELECTABLE COLOUR  
DUAL POWER

## PREMIER S9076TC DP/HP - 18W/40W

Non-dimmable 18/40 watt LED  
downlight with selectable CCT  
and power, IP64

### Application

Ideal for any residential or  
commercial interior space

### Design Specifications

- Premium aluminium body, IC-4 rated
- Stylish white trim
- Recessed opal polycarbonate diffuser
- High efficiency LED optics
- Remote, non-dimmable, dual power  
LED driver, with flex and plug
- Double insulated

### Performance

- Dimmable - Optional
- Dimmer Type, trailing edge, 1-10V, DALI / DSI

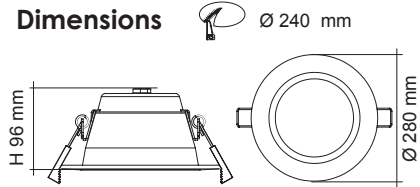

### Photometric Data S9076TC/WH/DP at 3000K

Unit: cd C0/C180 — C90/C270

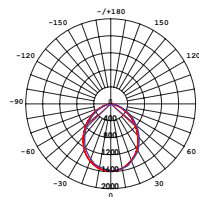

### Technical Specifications

Model No.	Input (V)/(Hz)	Power (W)	Lumen (lm)	CCT (K)	CRI	Beam Angle	Dimmable	Fitting Colour
S9076TC/WH/HP	240/50	18	2100/2300/2200	3000/4000/5700	> 80	90°	Optional	White
S9076TC/WH/DP	240/50	30/40	2600/3100/2800/3500/4200/3800	3000/4000/5700	> 80	90°	Optional	White

For interior products, the IP rating stated is from below the ceiling

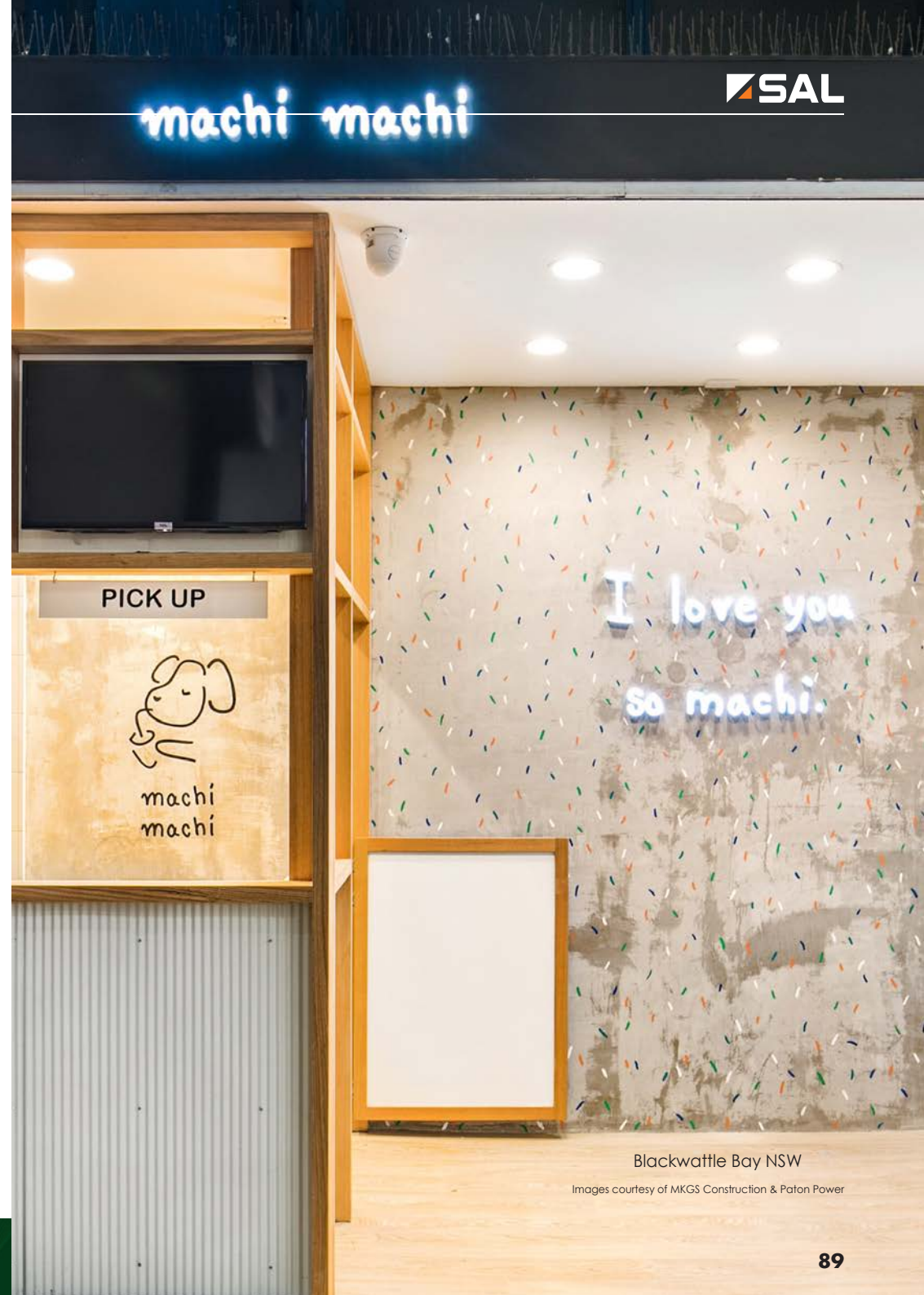

Blackwattle Bay NSW

Images courtesy of MKGS Construction & Paton Power



# RENMARK LED DOWNLIGHTS

# MIX & MATCH THE DOWNLIGHT TRIMS



TC SELECTABLE COLOUR



TC SELECTABLE COLOUR



## RENMARK S9081D10TC - 10W

10 watt LED downlight with selectable CCT, IP44

### Application

Ideal for any retail or commercial interior space

### Design Specifications

- Premium aluminium body profile
- Stylish white body profile and WH trim with optional WH square, BK round or BK square quick connect trims to order
- High performance mirror optical system, beam distribution 80°
- Remote, premium trailing edge dimmable flickerCONTROLLED LED driver, with flex and plug
- Selectable CCT 3000K / 4000K / 5700K
- IC - 4 rated, double insulated



### Dimensions

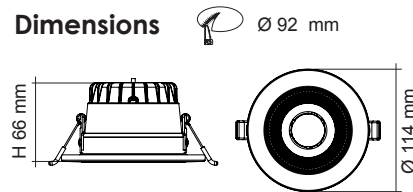

### Performance

- Dimmable, Trailing edge
- Dimming Options, 1-10V, DALI / DSI



### Photometric Data S9081D10TC/WH at 3000K

Unit: cd C0/C180 — C90/C270

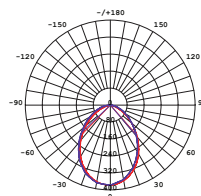

### Technical Specifications

Model No.	Input (V)/(Hz)	Power (W)	Lumen (lm)	CCT (K)	CRI	Beam Angle	Dimmable	Fitting Colour
S9081D10TC/WH	240/50	10	1000/1100/1050	3000/4000/5700	> 80	80°	Yes	White
Accessories	S9081RD/BK/P, S9081SQ/BK/P, S9081SQ/WH/P							



TC SELECTABLE COLOUR



## RENMARK S9081R10TC - 10W

10 watt LED downlight with selectable CCT, IP44

### Application

Ideal for any retail or commercial interior space

### Design Specifications

- Premium aluminium body profile
- Stylish white body profile and WH trim with optional WH square, BK round or BK square quick connect trims to order
- High performance faceted reflector profile, beam 60° , UGR <19
- Remote, premium trailing edge dimmable flickerCONTROLLED LED driver, with flex and plug
- Selectable CCT 3000K / 4000K / 5700K
- IC - 4 rated, double insulated



### Dimensions

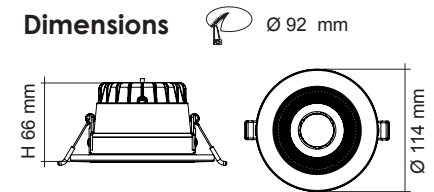

### Performance

- Dimmable, Trailing edge
- Dimming Options, 1-10V, DALI / DSI



### Photometric Data S9081R10TC/WH at 3000K

Unit: cd C0/C180 — C90/C270

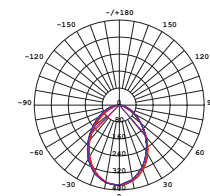

### Technical Specifications

Model No.	Input (V)/(Hz)	Power (W)	Lumen (lm)	CCT (K)	CRI	Beam Angle	Dimmable	Fitting Colour
S9081R10TC/WH	240/50	10	850/950/900	3000/4000/5700	> 80	60°	Yes	White
Accessories	S9081RD/BK/P, S9081SQ/BK/P, S9081SQ/WH/P							



For interior products, the IP rating stated is from below the ceiling

For terms of catalogue data use, refer to INDEX



sal.net.au



TC SELECTABLE COLOUR

DUAL POWER



## RENMARK S9082D20TC/DP - 14W/20W

14/20 watt LED downlight with selectable CCT and power, IP44

### Application

Ideal for any retail or commercial interior space

### Design Specifications

- Premium aluminium body profile
- Stylish white body profile and WH trim with optional WH square, BK round or BK square quick connect trims to order
- High performance mirror optical system, beam distribution 80°
- Remote, premium flickerCONTROLLED LED driver, with flex and plug
- Selectable CCT 3000K / 4000K / 5700K
- IC - 4 rated, double insulated



Dimensions Ø 145 mm

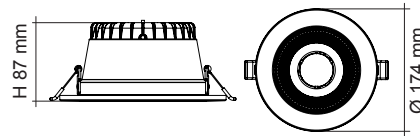

### Photometric Data S9082D20TC/DP at 3000K

Unit: cd C0/C180 — C90/C270

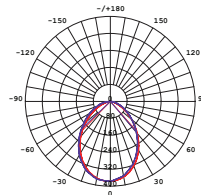

### Technical Specifications

Model No.	Input (V)/(Hz)	Power (W)	Lumen (lm)	CCT (K)	CRI	Beam Angle	Dimmable	Fitting Colour
S9082D20TC/DP	240/50	14 20	1550/1750/1600 2100/2400/2300	3000/4000/5700	> 80	80°	optional	White
Accessories	S9082RD/BK/P, S9082SQ/BK/P, S9082SQ/WH/P							



TC SELECTABLE COLOUR

DUAL POWER



## RENMARK S9082R20TC/DP - 14W/20W

14/20 watt LED downlight with selectable CCT and power, IP44

### Application

Ideal for any retail or commercial interior space

### Design Specifications

- Premium aluminium body profile
- Stylish white body profile and WH trim with optional WH square, BK round or BK square quick connect trims to order
- High performance faceted reflector profile, beam 60° , UGR <19
- Remote, premium flickerCONTROLLED LED driver, with flex and plug
- Selectable CCT 3000K / 4000K / 5700K
- IC - 4 rated, double insulated



Dimensions Ø 145 mm

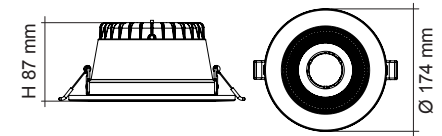

### Photometric Data S9082R20TC/DP at 3000K

Unit: cd C0/C180 — C90/C270

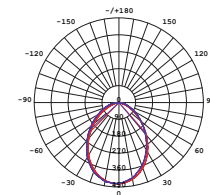

### Technical Specifications

Model No.	Input (V)/(Hz)	Power (W)	Lumen (lm)	CCT (K)	CRI	Beam Angle	Dimmable	Fitting Colour
S9082R20TC/DP	240/50	14 20	1250/1400/1300 1700/1900/1800	3000/4000/5700	> 80	60°	optional	White
Accessories	S9082RD/BK/P, S9082SQ/BK/P, S9082SQ/WH/P							



For interior products, the IP rating stated is from below the ceiling

For terms of catalogue data use, refer to INDEX



sal.net.au

95



TC SELECTABLE COLOUR

DUAL POWER



## RENMARK S9083D35TC/DP - 24W/35W

24/35 watt LED downlight with selectable CCT and power, IP44

### Application

Ideal for any retail or commercial interior space

### Design Specifications

- Premium aluminium body profile
- Stylish white body profile and WH trim with optional WH square, BK round or BK square quick connect trims to order
- High performance mirror optical system, beam distribution 80°
- Remote, non-dimmable flickerCONTROLLED LED driver, with flex and plug
- Selectable CCT 3000K / 4000K / 5700K
- IC - 4 rated, double insulated



Dimensions Ø 195 mm

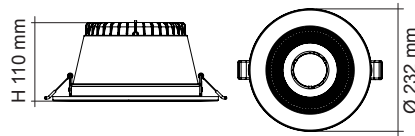

### Performance

- Dimming Options, trailing edge 1-10V, DALI / DSI



### Photometric Data S9083D35TC/DP at 3000K

Unit: cd C0/C180 — C90/C270

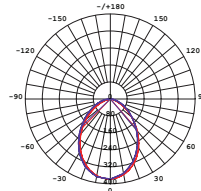

### Technical Specifications

Model No.	Input (V)/(Hz)	Power (W)	Lumen (lm)	CCT (K)	CRI	Beam Angle	Dimmable	Fitting Colour
S9083D35TC/DP	240/50	24 35	2500/2900/2800 3500/4000/3850	3000/4000/5700	> 80	80°	optional	White
Accessories	S9083RD/BK/P, S9083SQ/BK/P, S9083SQ/WH/P							



TC SELECTABLE COLOUR

DUAL POWER



## RENMARK S9083R35TC/DP - 24W/35W

24/35 watt LED downlight with selectable CCT and power, IP44

### Application

Ideal for any retail or commercial interior space

### Design Specifications

- Premium aluminium body profile
- Stylish white body profile and WH trim with optional WH square, BK round or BK square quick connect trims to order
- High performance faceted reflector profile, beam 60° , UGR <19
- Remote, non-dimmable flickerCONTROLLED LED driver, with flex and plug
- Selectable CCT 3000K / 4000K / 5700K
- IC - 4 rated, double insulated



Dimensions Ø 195 mm

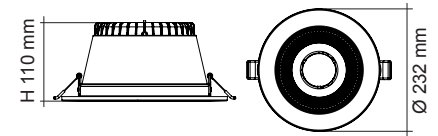

### Performance

- Dimming Options, trailing edge 1-10V, DALI / DSI



### Photometric Data S9083R35TC/DP at 3000K

Unit: cd C0/C180 — C90/C270

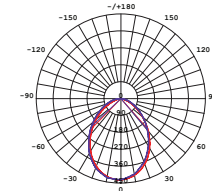

### Technical Specifications

Model No.	Input (V)/(Hz)	Power (W)	Lumen (lm)	CCT (K)	CRI	Beam Angle	Dimmable	Fitting Colour
S9083R35TC/DP	240/50	24 35	2150/2400/2300 3000/3300/3150	3000/4000/5700	> 80	60°	optional	White
Accessories	S9083RD/BK/P, S9083SQ/BK/P, S9083SQ/WH/P							



For interior products, the IP rating stated is from below the ceiling

For terms of catalogue data use, refer to INDEX



sal.net.au

97



TC SELECTABLE COLOUR

DUAL POWER



## RENMARK S9084D50TC/DP - 35W/50W

35/50 watt LED downlight with selectable CCT and power, IP44

### Application

Ideal for any retail or commercial interior space

### Design Specifications

- Premium aluminium body profile
- Stylish white body profile and WH trim with optional WH square, BK round or BK square quick connect trims to order
- High performance mirror optical system, beam distribution 80°
- Remote, non-dimmable flickerCONTROLLED LED driver, with flex and plug
- Selectable CCT 3000K / 4000K / 5700K
- CA90 rated, double insulated



Dimensions Ø 245 mm

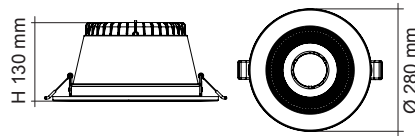

### Performance

- Dimming Options, trailing edge 1-10V, DALI / DSI



### Photometric Data S9084D50TC/DP at 3000K

Unit: cd C0/C180 — C90/C270

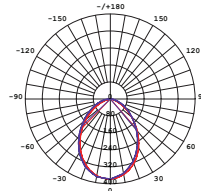

### Technical Specifications

Model No.	Input (V)/(Hz)	Power (W)	Lumen (lm)	CCT (K)	CRI	Beam Angle	Dimmable	Fitting Colour
S9084D50TC/DP	240/50	35 50	3150/3650/3500 4500/5250/5000	3000/4000/5700	> 80	80°	optional	White
Accessories	S9084RD/BK/P, S9084SQ/BK/P, S9084SQ/WH/P							



TC SELECTABLE COLOUR

DUAL POWER



## RENMARK S9084R50TC/DP - 35W/50W

35/50 watt LED downlight with selectable CCT and power, IP44

### Application

Ideal for any retail or commercial interior space

### Design Specifications

- Premium aluminium body profile
- Stylish white body profile and WH trim with optional WH square, BK round or BK square quick connect trims to order
- High performance faceted reflector profile, beam 60° , UGR <19
- Remote, non-dimmable flickerCONTROLLED LED driver, with flex and plug
- Selectable CCT 3000K / 4000K / 5700K
- CA90 rated, double insulated



Dimensions Ø 245 mm

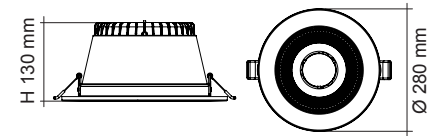

### Performance

- Dimming Options, trailing edge 1-10V, DALI / DSI



### Photometric Data S9084R50TC/DP at 3000K

Unit: cd C0/C180 — C90/C270

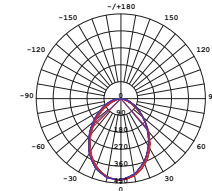

### Technical Specifications

Model No.	Input (V)/(Hz)	Power (W)	Lumen (lm)	CCT (K)	CRI	Beam Angle	Dimmable	Fitting Colour
S9084R50TC/DP	240/50	35 50	2800/3150/3950 4000/4500/4250	3000/4000/5700	> 80	60°	optional	White
Accessories	S9084RD/BK/P, S9084SQ/BK/P, S9084SQ/WH/P							



For interior products, the IP rating stated is from below the ceiling

For terms of catalogue data use, refer to INDEX



sal.net.au

99

98



## STAR SPOT S9361CW - 4W

Compact design LED 4 watt downlight

### Application

Ideal for any residential feature lighting or commercial interior spaces

### Design Specifications

- 42mm diameter trim face, low profile design, 35mm cut-out
- Available in Satin Nickel or White finish
- Durable aluminium body profile
- CCT 4000K, 250 lumens
- High output LED optics, 40° beam distribution
- Two options available, (1) with a non-dimmable (4 watt system) remote driver, with flex and plug or (2) 12V DC head assembly only
- Class III (head only), KIT double insulated

### Performance

- Non-dimmable



### Technical Specifications

Model No.	Input (V)/(Hz)	Power (W)	Lumen (lm)	CCT (K)	CRI	Beam Angle	Dimmable	Fitting Colour
S9361CW/WH	240/50	4	250	4000	> 80	40°	No	White
S9361CW/SN	240/50	4	250	4000	> 80	40°	No	Satin Nickel
S9361CW/WH/ND	12V DC	3	250	4000	> 80	40°	No	White
S9361CW/SN/ND	12V DC	3	250	4000	> 80	40°	No	Satin Nickel



### Dimensions

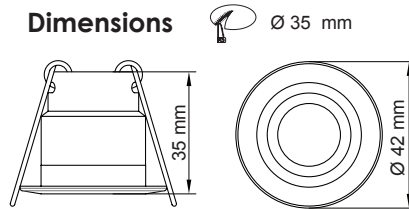

### Photometric Data

S9361CW at 4000K

Unit: cd C0/C180 — C90/C270

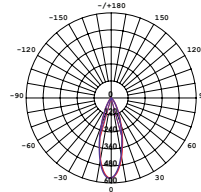

For interior products, the IP rating stated is from below the ceiling



INTERIOR LIGHTING

# SMARTER LIGHTING CHOICES

Rover - Burwood NSW



## STAR SPOT II S9362WW - 3W

Compact design LED  
3 watt downlight

### Application

Ideal for any residential feature lighting or commercial interior space

### Design Specifications

- 35mm diameter trim face, low profile design, 30mm cut-out
- Available in Black or White finish
- Durable aluminium body profile
- CCT 3000K, 170 lumens, CRI>80
- High output LED optics, 30° beam distribution
- Designed with a remote, dimmable driver, complete with flex and plug
- Double insulated

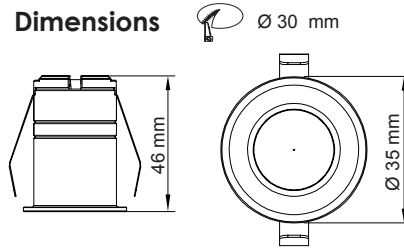

### Performance

- Dimmable, Trailing edge



### Photometric Data S9362WW at 3000K

Unit: cd C0/C180 — C90/C270

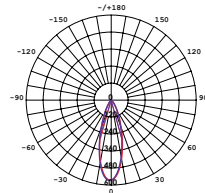

### Technical Specifications

Model No.	Input (V)/(Hz)	Power (W)	Lumen (lm)	CCT (K)	CRI	Beam Angle	Dimmable	Fitting Colour
S9362WW/WH	240/50	3	170	3000	> 80	30°	Yes	White
S9362WW/BK	240/50	3	170	3000	> 80	30°	Yes	Black



## STAR SPOT II S9363WW - 7W

Compact design LED  
7 watt downlight

### Application

Ideal for any residential feature lighting or commercial interior space

### Design Specifications

- 55mm diameter trim face, low profile design, 50mm cut-out
- Available in Black or White finish
- Durable aluminium body profile
- CCT 3000K, 470 lumens, CRI>80
- High output LED optics, 30° beam distribution
- Designed with a remote, dimmable driver, complete with flex and plug
- Double insulated

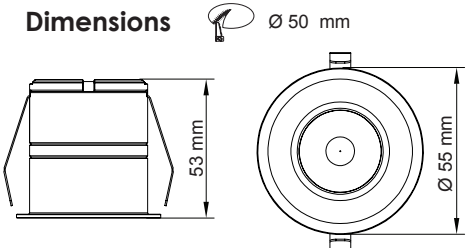

### Performance

- Dimmable, Trailing edge



### Photometric Data S9363WW at 3000K

Unit: cd C0/C180 — C90/C270

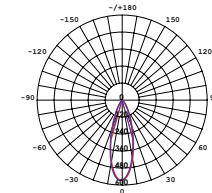

### Technical Specifications

Model No.	Input (V)/(Hz)	Power (W)	Lumen (lm)	CCT (K)	CRI	Beam Angle	Dimmable	Fitting Colour
S9363WW/WH	240/50	7	470	3000	> 80	30°	Yes	White
S9363WW/BK	240/50	7	470	3000	> 80	30°	Yes	Black



For interior products, the IP rating stated is from below the ceiling

For terms of catalogue data use, refer to INDEX







TC SELECTABLE COLOUR  
DUAL POWER

## SURFACE SPOT SMT9017TC - 10/15W

Dimmable 10/15 watt LED downlight with selectable CCT and power.

### Application

Ideal for any residential feature lighting or commercial interior space

### Design Specifications

- Selectable CCT 3000K / 4000K / 5700K
- Durable Polyamide body profile
- Surface mount
- Integral, dimmable control gear with selectable power
- Choice of Black or White finish
- 40° beam distribution, optional 60°, CRI>80
- Double insulated

### Performance

- Dimmable, trailing edge



### Technical Specifications

Model No.	Input (V)/(Hz)	Power (W)	Lumen (lm)	CCT (K)	CRI	Beam Angle	Dimmable	Fitting Colour
SMT9017TC/WH	240/50	10 15	580/700/630 1000/1150/1100	3000/4000/5700	> 80	40°	Yes	White
SMT9017TC/BK	240/50	10 15	580/700/630 1000/1150/1100	3000/4000/5700	> 80	40°	Yes	Black



### Dimensions

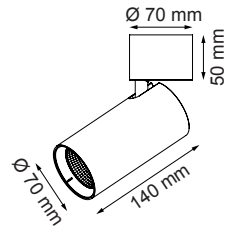

### Photometric Data SMT9017TC at 3000K

Unit: cd C0/C180 C30/C210  
C60/C240 C90/C270

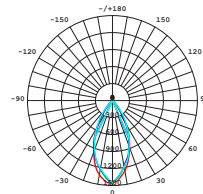

TC SELECTABLE COLOUR

## TRADEGEM S9140TC2 - 8W

Dimmable 8 watt LED downlight with selectable CCT, IP44

### Application

Ideal for any residential or commercial interior space

### Design Specifications

- Selectable CCT 3000K/4000K/5700K
- Durable Polyamide, reinforced aluminium body profile, IC-4 rated
- Stylish white powder coat finish
- Quality opal polycarbonate diffuser
- High efficiency LED optics
- Trailing edge dimmable LED driver, with flex and plug
- Deco ring options - Satin Nickel (S9140SN/RING)
- Double insulated

### Performance

- Dimmable, Trailing edge



### Technical Specifications

Model No.	Input (V)/(Hz)	Power (W)	Lumen (lm)	CCT (K)	CRI	Beam Angle	Dimmable	Fitting Colour
S9140TC2WH	240/50	8	800/950/900	3000/4000/5700	> 80	90°	Yes	White



### Dimensions

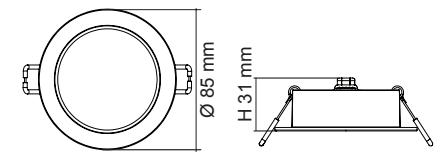

### Photometric Data S9140TC2WH at 3000K

Unit: cd C0/C180 C90/C270

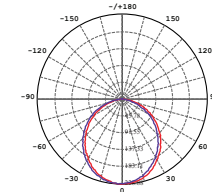

For interior products, the IP rating stated is from below the ceiling

For terms of catalogue data use, refer to INDEX



sal.net.au



**SAL**

TC SELECTABLE COLOUR

## TRADEGEM S9141TC2WH - 9W

Dimmable 9 watt LED downlight with selectable CCT, IP44

### Application

Ideal for any residential or commercial interior space

### Design Specifications

- Selectable CCT 3000K/4000K/5700K
- Durable Polyamide, aluminium reinforced body profile, IC-4 rated
- Stylish white finish
- Quality opal polycarbonate diffuser
- High efficiency LED optics
- Trailing edge dimmable LED driver with flex and plug
- Colour trim options: Satin Nickel (S9141SN/RING), Black (S9141BK/RING)
- Double insulated



Dimensions Ø 92 mm

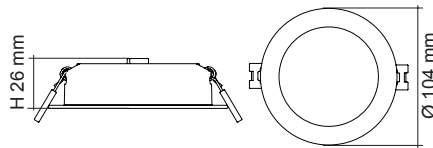

### Performance

- Dimmable, Trailing edge



Photometric Data S9141TC2WH at 3000K

Unit: cd C0/C180 — C90/C270

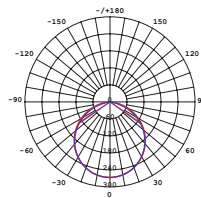

### Technical Specifications

Model No.	Input (V)/(Hz)	Power (W)	Lumen (lm)	CCT (K)	CRI	Beam Angle	Dimmable	Fitting Colour
S9141TC2WH	240/50	9	900/1050/1000	3000/4000/5700	> 80	110°	Yes	White



**SAL**

TC SELECTABLE COLOUR

## TRADEGEM S9141TC SM - 9W

Dimmable 9 watt surface mount LED downlight with selectable CCT, IP20

### Application

Ideal for any surface mount, residential or commercial interior space

### Design Specifications

- Selectable CCT 3000K/4000K/5700K
- Durable aluminium surface mount body profile, IP20
- Stylish white or black powder coat finish
- Quality opal polycarbonate diffuser
- High efficiency LED optics
- Integral, trailing edge dimmable LED driver



S9141TC/WH/SM

S9141TC/BK/SM

Dimensions

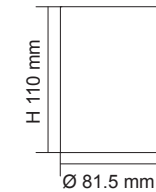

### Performance

- Dimmable, trailing edge



Photometric Data S9141TC SM at 4000K

Unit: cd C0/C180 — C90/C270

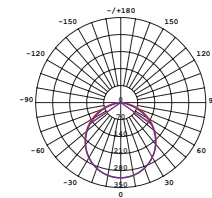

### Technical Specifications

Model No.	Input (V)/(Hz)	Power (W)	Lumen (lm)	CCT (K)	CRI	Beam Angle	Dimmable	Fitting Colour
S9141TC/WH/SM	240/50	9	700/850/800	3000/4000/5700	> 80	90°	Yes	White
S9141TC/BK/SM	240/50	9	700/850/800	3000/4000/5700	> 80	90°	Yes	Black



For interior products, the IP rating stated is from below the ceiling

For terms of catalogue data use, refer to INDEX



sal.net.au

107



TC SELECTABLE COLOUR

## TRI-GEM + S9842CS - 10W

Dimmable 10 watt LED downlight with DIY selectable CCT, IP44

### Application

Ideal for any residential or commercial interior space

### Design Specifications

- Easy DIY selectable CCT with the flick of a switch, no need to access the fixture and fully compatible with the SAL PIXIE app functionality when connected to a SAL PIXIE dimmer
- Durable aluminium recessed mount body profile, white trim, IC-4 and IP44 rated
- 10 watt integral control gear with smooth dimming functionality
- Opal PC diffuser
- Double insulated

### Performance

- Dimmable, Trailing edge



Dimensions Ø 92 mm

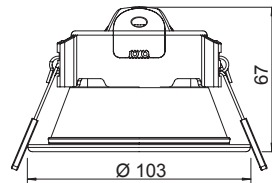

Photometric Data S9842CS at 3000K

Unit: cd C0/C180 — C90/C270

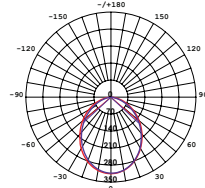

# THE TRIGEM+ DOWNLIGHT WITH DIY COLOUR SELECT TOO EASY

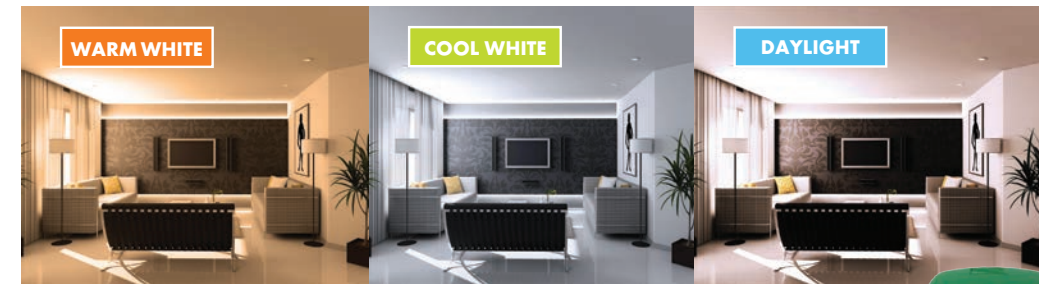

### Technical Specifications

Model No.	Input (V)/(Hz)	Power (W)	Lumen (lm)	CCT (K)	CRI	Beam Angle	Dimmable	Fitting Colour
S9842CS/WH	240/50	10	800/900/850	3000/4000/5700	> 80	90°	Yes	White

Designed with an integral 10 watt high performance dimmable driver and flex & plug for easy installation, you can change the colour temperature with the flick of your wall switch, or with the smarts of the SAL PIXIE app and SAL PIXIE dimmer; all too easy with DIY colour select inside.



For interior products, the IP rating stated is from below the ceiling



TC SELECTABLE COLOUR

## UNIFIT S9008TC2 - 10W

Dimmable fixed 10 watt LED downlight, with selectable CCT

### Application

Ideal for any residential or commercial interior space



### Design Specifications

- Durable die-cast aluminium body profile
- Stylish white or black powder coat finish
- High output LED optics
- Multi-faceted reflector system, 60° beam distribution.
- Polycarbonate optical lens
- Remote, trailing edge dimmable LED driver with flex and plug
- Double insulated

Dimensions Ø 76 mm

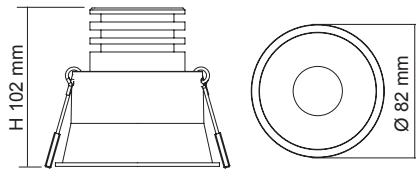

### Performance

- Dimmable, Trailing edge
- Dimming Options, 1-10V, DALI / DSI



Photometric Data S9008TC at 3000K

Unit: cd C0/C180 — C90/C270

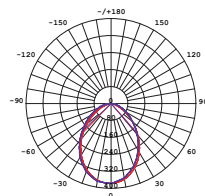

### Technical Specifications

Model No.	Input (V)/(Hz)	Power (W)	Lumen (lm)	CCT (K)	CRI	Beam Angle	Dimmable	Fitting Colour
S9008TC2WH	240/50	10	750/900/850	3000/4000/5700	> 80	60°	Yes	Mat White
S9008TC2BK	240/50	10	750/900/850	3000/4000/5700	> 80	60°	Yes	Black



TC SELECTABLE COLOUR

## UNIFIT S9009TC2 - 10W

Centre tilt 23° dimmable 10 watt LED downlight, with selectable CCT

### Application

Ideal for any residential or commercial interior space



### Design Specifications

- Durable die-cast aluminium body profile
- Stylish white or black powder coat finish
- High output LED optics
- Multi-faceted reflector system, 60° beam distribution.
- Polycarbonate optical lens
- Remote, trailing edge dimmable LED driver with flex and plug
- Double insulated

Dimensions Ø 76 mm

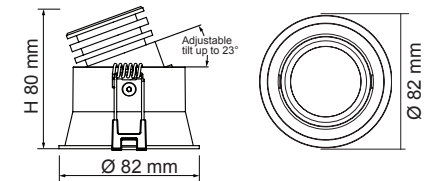

### Performance

- Dimmable, Trailing edge
- Dimming Options, 1-10V, DALI / DSI



Photometric Data S9009TC at 3000K

Unit: cd C0/C180 — C90/C270

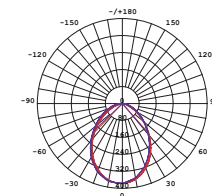

### Technical Specifications

Model No.	Input (V)/(Hz)	Power (W)	Lumen (lm)	CCT (K)	CRI	Beam Angle	Dimmable	Fitting Colour
S9009TC2WH	240/50	10	750/900/850	3000/4000/5700	> 80	60°	Yes	Mat White
S9009TC2BK	240/50	10	750/900/850	3000/4000/5700	> 80	60°	Yes	Black



For interior products, the IP rating stated is from below the ceiling

For terms of catalogue data use, refer to INDEX



sal.net.au



TC SELECTABLE COLOUR

## UNIFIT S9011TC2 - 10W

Fixed dimmable 10 watt LED  
downlight, with selectable CCT

### Application

Ideal for any residential or  
commercial interior space



### Design Specifications

- Durable die-cast aluminium body profile
- Stylish white or black powder coat finish
- High output LED optics, polycarbonate lens, 60° beam distribution
- Remote, trailing edge dimmable LED driver with flex and plug
- Double insulated

### Dimensions

Ø 92 mm

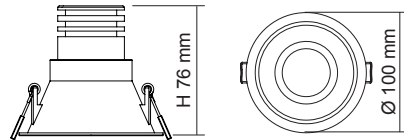

### Performance

- Dimmable, Trailing edge
- Dimming Options, 1-10V, DALI / DSI



### Photometric Data S9011TC2 at 3000K

Unit: cd C0/C180 — C90/C270

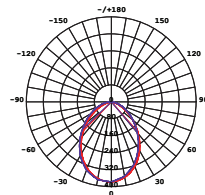

### Technical Specifications

Model No.	Input (V)/(Hz)	Power (W)	Lumen (lm)	CCT (K)	CRI	Beam Angle	Dimmable	Fitting Colour
S9011TC2WH	240/50	10	750/900/850	3000/4000/5700	> 80	60°	Yes	Mat White
S9011TC2BK	240/50	10	750/900/850	3000/4000/5700	> 80	60°	Yes	Black



For interior products, the IP rating stated is from below the ceiling

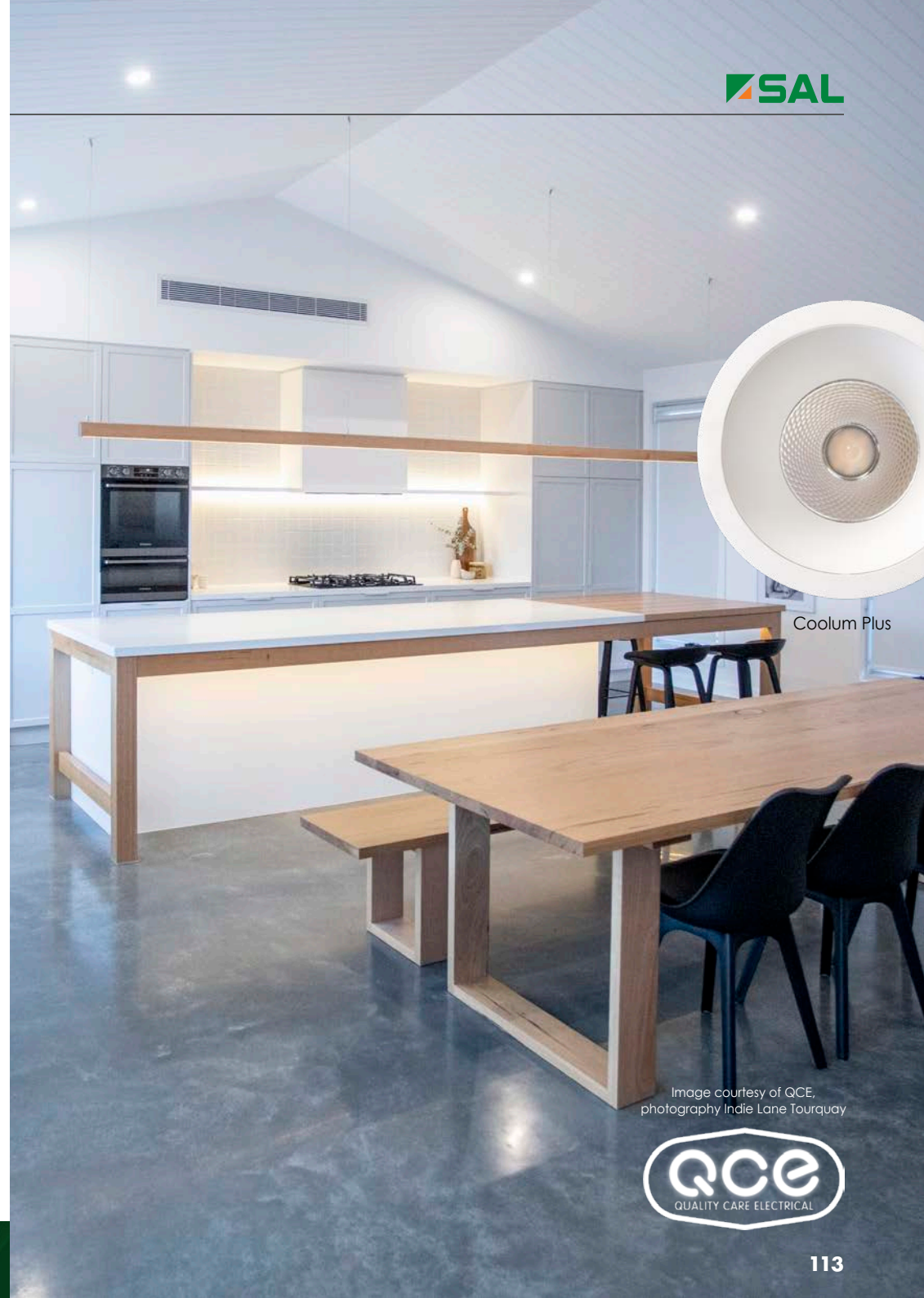

Coolum Plus

Image courtesy of QCE,  
photography Indie Lane Tourquay





TC SELECTABLE COLOUR



## UNIFIT S9053WP/RS - 9W

Dimmable 9 watt LED module, with selectable CCT and rippleSHIELD

### Application

Ideal for any residential or commercial interior space, experiencing nuisance ripple induced flicker

### Design Specifications

- Combined with the SAL SDD400SFI dimmer, the rippleSHIELD Coolum eliminates ALL nuisance non-visible and visible flicker caused by ripple injection
- Remote rippleSHIELD dimmable LED driver, with smooth dimming performance down to 1.0% of light output, designed with flex & plug
- High output LED optics, 3000K CCT, CRI>80
- A comprehensive range of downlight trims are available, see MIX & MATCH model numbers
- Double insulated



### Dimensions

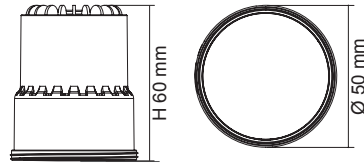

### Photometric Data S9053WP/SFI at 3000K

Unit: cd C0/C180 — C90/C270

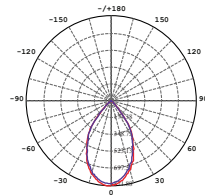

### Performance

- Dimmable - only with SDD400SFI dimmer



### Technical Specifications

Model No.	Input (V)/(Hz)	Power (W)	Lumen (lm)	CCT (K)	CRI	Beam Angle	Dimmable
S9053WP/SFI	240/50	9	700	3000	> 80	60°	Yes
SDD400SFI	240/50			DIMMER			Yes

For interior products, the IP rating stated is from below the ceiling



TC SELECTABLE COLOUR

## MIX AND MATCH THE TRIM PROFILES



S9008WW/BK/SFI

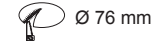

S9009WW/BK/SFI

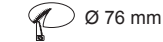

S9011WW/BK/SFI

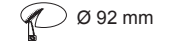

S9008WW/WH/SFI

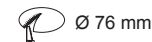

S9009WW/WH/SFI

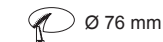

S9011WW/WH/SFI

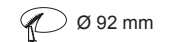

S9008WW/WH/SFI



S9009WW/WH/SFI



S9011WW/WH/SFI

For terms of catalogue data use, refer to INDEX





TC SELECTABLE COLOUR

## UNIFIT S9053TCP2 - 10W

Dimmable 10 watt LED module,  
with selectable CCT

### Application

Ideal for any residential or  
commercial interior space

### Design Specifications

- Efficient die-cast aluminium heat sink
- High output LED optics
- Multi-faceted reflector system,  
60° beam distribution
- Polycarbonate optical lens
- Remote, trailing edge dimmable LED  
driver, fitted with flex and plug
- A comprehensive range of downlight  
trims are available, see MIX & MATCH  
model numbers
- Double insulated



### Dimensions

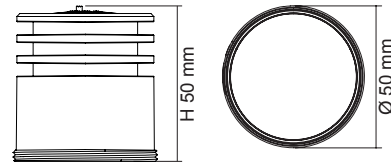

### Photometric Data S9053TCP2 at 3000K

Unit: cd C0/C180 — C90/C270

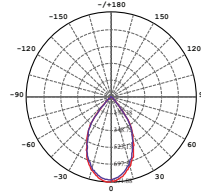

### Performance

- Dimmable, Trailing edge
- Dimming Options, 1-10V, DALI / DSI,  
rippleSHIELD



### Technical Specifications

Model No.	Input (V)/(Hz)	Power (W)	Lumen (lm)	CCT (K)	CRI	Beam Angle	Dimmable
S9053TCP2	240/50	10	750/900/850	3000/4000/5700	> 80	60°	Yes



TC SELECTABLE COLOUR

### MIX AND MATCH THE TRIM PROFILES



S9008TC2BK  
Ø 76 mm



S9009TC2BK  
Ø 76 mm



S9011TC2BK  
Ø 92 mm



S9008TC2WH  
Ø 76 mm



S9009TC2WH  
Ø 76 mm



S9011TC2WH  
Ø 92 mm



S9008TC2WH



S9009TC2WH



S9011TC2WH



For interior products, the IP rating stated is from below the ceiling

For terms of catalogue data use, refer to INDEX



sal.net.au

117



## UNIFIT S9053HC - 8W

Dimmable 8 watt LED module, CRI >90

### Application

Ideal for any residential or commercial interior space

### Design Specifications

- Efficient die-cast aluminium heat sink
- High output LED optics, CRI >90
- Multi-faceted reflector system 60° beam distribution
- Polycarbonate optical lens
- Remote, trailing edge dimmable LED driver, fitted with flex and plug
- A comprehensive range of downlight trims are available, see MIX & MATCH model numbers
- Double insulated

### Performance

- Dimmable, Trailing edge
- Dimming Options, 1-10V, DALI / DSI, rippleSHIELD



### Dimensions

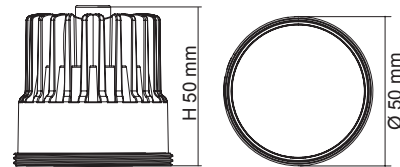

### Photometric Data S9053HC/WP at 3000K

Unit: cd C0/C180 — C90/C270

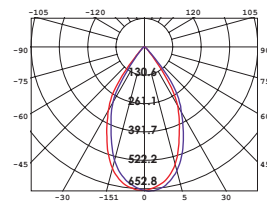

### MIX AND MATCH THE TRIM PROFILES



S9008HC/BK  
Ø 76 mm



S9009HC/BK  
Ø 76 mm



S9011HC/BK  
Ø 92 mm



S9008HC/WH  
Ø 76 mm



S9009HC/WH  
Ø 76 mm



S9011HC/WH  
Ø 92 mm



S9008HC/WH



S9009HC/WH



S9011HC/WH

### Technical Specifications

Model No.	Input (V)/(Hz)	Power (W)	Lumen (lm)	CCT (K)	CRI	Beam Angle	Dimmable	Fitting Colour
S9053HC/WP	240/50	8W	620	3000	> 90	60°	Yes	White



For interior products, the IP rating stated is from below the ceiling

For terms of catalogue data use, refer to INDEX





TC SELECTABLE COLOUR  
DUAL POWER

## UNITREK SRC9017TC - 10/15W

Dimmable, 10/15 watt LED downlight with selectable CCT and power.

### Application

Ideal for any residential feature lighting or commercial interior space

### Design Specifications

- Selectable CCT 3000K / 4000K / 5700K
- Durable Polyamide body profile
- Recessed mount, cut-out 72mm
- Integral, dimmable control gear, selectable power with flex and plug
- Choice of Black or White finish
- CRI>80, standard 40° beam distribution, optional 60°
- Double insulated



### Dimensions

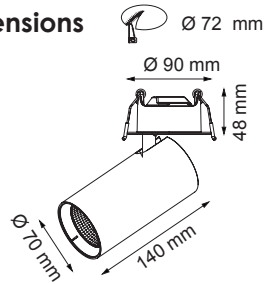

### Photometric Data S9140TC at 3000K

Unit: cd C0/C180 — C90/C270

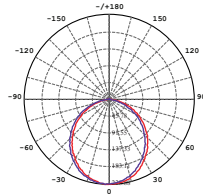

### Performance

- Dimmable, trailing edge



### Technical Specifications

Model No.	Input (V)/(Hz)	Power (W)	Lumen (lm)	CCT (K)	CRI	Beam Angle	Dimmable	Fitting Colour
SRC9017TC/WH	240/50	10	580/700/630	3000/4000/5700	> 80	40°	Yes	White
		15	1000/1150/1100					
SRC9017TC/BK	240/50	10	580/700/630	3000/4000/5700	> 80	40°	Yes	Black
		15	1000/1150/1100					

For interior products, the IP rating stated is from below the ceiling



# COLOUR TEMPERATURE, THERE IS A DIFFERENCE



Lighting is more than just brightness or lumens. Make sure you take the time to select the right colour temperature to create the best visual appearance; your eyes don't tell lies!





TC SELECTABLE COLOUR

## WAVE S9064TC - 7W

Dimmable LED downlight with selectable CCT, IP44

### Application

Ideal for any residential or commercial interior space

### Design Specifications

- Selectable CCT 3000K / 4000K / 5700K
- Poly covered aluminium body
- Quality opal polycarbonate diffuser
- Integral, trailing edge dimmable LED driver, with flex and plug
- High efficiency LED optics
- Deco ring options: Satin Nickel (S9064SN/RING), Black (S9064BK/RING)
- IC - 4 rated, double insulated



Dimensions Ø 72 mm

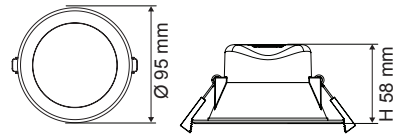

### Performance

- Dimmable, trailing edge



### Photometric Data S9064TC at 3000K

Unit: cd C0/C180 — C90/C270

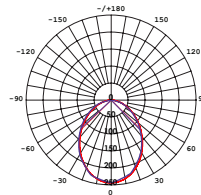

### Technical Specifications

Model No.	Input (V)/(Hz)	Power (W)	Lumen (lm)	CCT (K)	CRI	Beam Angle	Dimmable	Fitting Colour
S9064TC WH	240/50	7	750/850/800	3000/4000/5700	> 80	90°	Yes	White



TC SELECTABLE COLOUR

## WAVE S9065TC - 8W

Dimmable LED downlight with selectable CCT, IP44

### Application

Ideal for any residential or commercial interior space

### Design Specifications

- Selectable CCT 3000K / 4000K / 5700K
- Poly covered aluminium body
- Quality opal polycarbonate diffuser
- Integral, trailing edge dimmable LED driver, with flex and plug
- High efficiency LED optics
- Deco ring options: Satin Nickel (S9065SN/RING), Black (S9065BK/RING)
- IC - 4 rated, double insulated



Dimensions Ø 92 mm

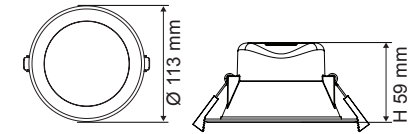

### Performance

- Dimmable, trailing edge



### Photometric Data S9065TC at 3000K

Unit: cd C0/C180 — C90/C270

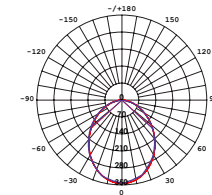

### Technical Specifications

Model No.	Input (V)/(Hz)	Power (W)	Lumen (lm)	CCT (K)	CRI	Beam Angle	Dimmable	Fitting Colour
S9065TC WH	240/50	8	800/950/850	3000/4000/5700	> 80	90°	Yes	White

For interior products, the IP rating stated is from below the ceiling

For terms of catalogue data use, refer to INDEX





TC SELECTABLE COLOUR



## WAVE S9065TC FG - 8W

Dimmable 8 watt LED downlight with selectable CCT and flickerGUARD

### Application

Ideal for any residential or commercial interior space, experiencing nuisance harmonic induced flicker

### Design Specifications

- The innovative flickerGUARD Wave responds to both visual and non-visual harmonic induced flicker.
- Selectable CCT 3000K / 4000K / 5700K
- Integral flickerGUARD trailing edge dimmable LED driver, with smooth dimming performance, designed with flex and plug for easy installation.
- Poly covered aluminium body,
- Deco ring options: Satin Nickel (S9065SN/RING), Black (S9065BK/RING)
- IC - 4 rated, double insulated



Dimensions Ø 92 mm

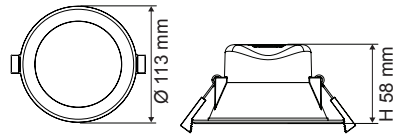

### Performance

- Dimmable, trailing edge



### Photometric Data S9065TC/WH/FG at 3000K

Unit: cd C0/C180 — C90/C270

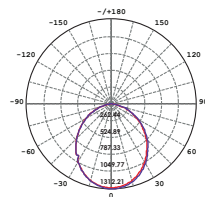

### Technical Specifications

Model No.	Input (V)/(Hz)	Power (W)	Lumen (lm)	CCT (K)	CRI	Beam Angle	Dimmable	Fitting Colour
S9065TC/WH/FG	240/50	8	800/950/850	3000/4000/5700	> 90	90°	Yes	White



For interior products, the IP rating stated is from below the ceiling



# FlickerGUARD™ MORE THAN FLICKER CONTROL.

Fed up with LED flicker? The solution is the innovative flickerGUARD™ series from SAL, offering a reliable solution for visual and non-visual harmonic flicker.



TC SELECTABLE COLOUR

## WAVE SE S9065TC/MS - 9W

Recessed 9 watt LED downlight with microwave sensor control and selectable CCT, IP44

### Application

Ideal for interior service areas, bathrooms and storage spaces

### Design Specifications

- Selectable CCT 3000K / 4000K / 5700K and microwave sensor control
- Poly covered aluminium body
- Opal polycarbonate diffuser
- Integral, non-dimmable LED driver, with flex and plug
- Microwave sensor adjustments - 5sec/90sec/5min/30min, daylight threshold 30 lux, detection distances Ø 8M @ 2.4hm
- Manual override function
- Deco ring options - Satin Nickel (S9065SN/RING), Black (S9065BK/RING)
- IC - 4 rated, double insulated

### Performance

- Non-dimmable



Dimensions Ø 92 mm

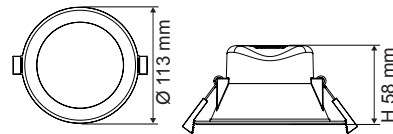

### Photometric Data S9065TC/MS at 3000K

Unit: cd C0/C180 — C90/C270

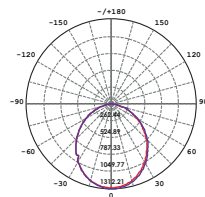

### Technical Specifications

Model No.	Input (V)/(Hz)	Power (W)	Lumen (lm)	CCT (K)	CRI	Beam Angle	Dimmable	Fitting Colour
S9065TC/MS	240/50	9	700/850/800	3000/4000/5700	> 80	90°	No	White



For interior products, the IP rating stated is from below the ceiling



# WAVE SE S9065TC/MS



## TC SELECTABLE COLOUR

WARM WHITE <b>3000K</b>	COOL WHITE <b>4000K</b>	DAYLIGHT <b>5700K</b>
----------------------------	----------------------------	--------------------------

Daylight and movement sensor adjustments



TC SELECTABLE COLOUR

## WAVE S9066TC - 12W

Dimmable IP44 LED downlight  
with selectable CCT

### Application

Ideal for any residential or  
commercial interior space

### Design Specifications

- Selectable CCT 3000K/4000K/5700K
- Poly covered aluminium body,  
IC - 4 rated, double insulated
- Opal polycarbonate diffuser
- Integral, trailing edge dimmable LED  
driver, with flex and plug
- High efficiency LED optics
- Deco ring options:  
Satin Nickel (S9066SN/RING),  
Black (S9066BK/RING)



**Dimensions**  Ø 125 mm

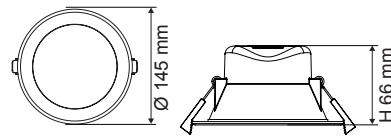

### Performance

- Dimmable, trailing edge



**Photometric Data** S9066TC at 3000K

Unit: cd C0/C180 — C90/C270

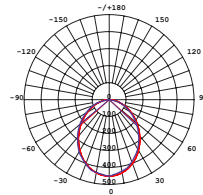

### Technical Specifications

Model No.	Input (V)/(Hz)	Power (W)	Lumen (lm)	CCT (K)	CRI	Beam Angle	Dimmable	Fitting Colour
S9066TC WH	240/50	12	1300/1450/1350	3000/4000/5700	> 80	90°	Yes	White



For interior products, the IP rating stated is from below the ceiling



WAVE - S9066TC





## DOWNLIGHT FITTINGS S9001, S9003

Low voltage LED downlight kits (Round)

### Select your downlight in three easy steps



#### Step 1 - Select your downlight head profile

##### Technical Specifications

Model No.	Head	Fitting Colour	Cut Out (Ø)	Dimensions (Ø)
S9001BK	Fixed head, twist lock	Black	72mm	81mm
S9001WH	Fixed head, twist lock	White	72mm	81mm
S9001SC	Fixed head, twist lock	Satin Chrome	72mm	81mm
S9003BK	Gimbal 45°, twist lock	Black	92mm	103mm
S9003WH	Gimbal 45°, twist lock	White	92mm	103mm
S9003SC	Gimbal 45°, twist lock	Satin Chrome	92mm	103mm

#### Step 2 - Select your driver type

##### Electronic transformers (please select one for MR16 lamps)

Model No.	Input (V)/(Hz)	Power (W)	Output (V)	Power Factor	Dimensions (L x W x H mm)	1.2 m flex & 2 pin plug fitted
MINI60	240/50	20-60	11.5	0.99	109 x 42 x 24	No
MINI/P60	240/50	20-60	11.5	0.99	109 x 42 x 24	Yes

OR

##### Dimmable LED modules (please select one)

Model No.	Input (V)/(Hz)	Power (W)	Lumen (lm)	CCT (K)	CRI	Beam Angle	Dimmable
S9053HC/WP	240/50	8	620	3000	> 90	60°	Yes
S9053WW/RS	240/50	9	700	3000	> 80	60°	Yes



### Step 3 - Select your lamp type and you are ready to go!



MR16/5W/TC



MR16/7W/TC



MR16DIM9



ACCESSORY S9000LH



MR16CC7KIT/WW



S9053WP/RS



S9053HC/WP

##### Low voltage LED globes (please select one)

Model No.	Input (AC/DC)	Power (W)	Lumen (lm)	CCT (K)	Beam Angle	Dimmable	Lamp Base	Dimensions (D x H mm)
MR16/5W/TC	12 V	4	360/400/380	3000/4000/6000	38°	No	GU5.3	50 x 55
MR16/7W/TC	12 V	6	500/600/380	3000/4000/6000	38°	No	GU5.3	50 x 55
MR16DIM9WW	12 V	9	550	3000	60°	Yes	GU5.3	50 x 49
MR16DIM9CW	12 V	9	550	4000	60°	Yes	GU5.3	50 x 49
MR16DIM9DL	12 V	9	550	6000	60°	Yes	GU5.3	50 x 49



For interior products, the IP rating stated is from below the ceiling

For terms of catalogue data use, refer to INDEX



## ADAPTOR PLATES S9901, S9903, S9931, S9933

Interior downlight adaptor plates

### Design Specifications

- Pressed steel plate, black, satin nickel, matt white, or gloss white powder coat finish

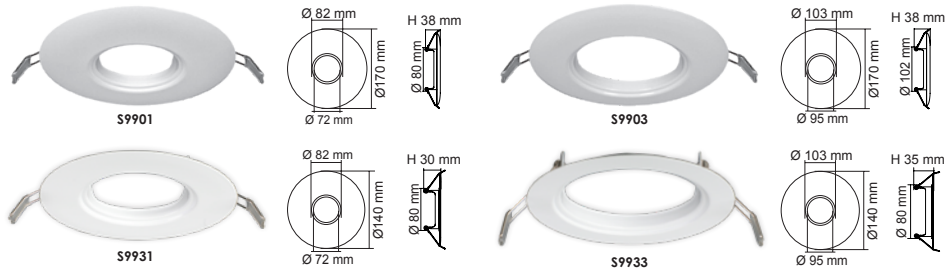

### Technical Specifications

Model No.	Internal (D mm)	Overall (D mm)	Colour	Suits
S9901BK	72	170	Black	S9001BK
S9903BK	95	170	Black	S9003BK
S9903WH	95	170	Matt White	S9146WH, S9048WH, S9141WH, S9842WH
S9903GWH	95	170	Gloss White	S9041WH, S9046WH
S9931WH	72	140	Matt White	S9145WH
S9933WH	95	140	Matt White	S9146WH, S9048WH, S9141WH, S9842WH

## REDUCER RINGS S9922, S9923

Interior downlight adaptor plates

### Design Specifications

- Adaptor plate, gloss white powder coat finish

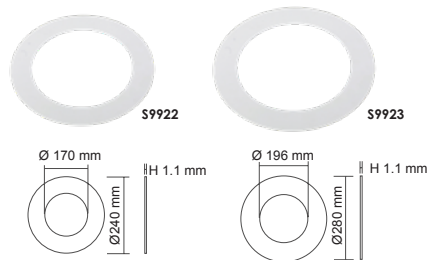

### Technical Specifications

Model No.	Internal (D mm)	Overall (D mm)	Colour	Suits
S9922	170	240	White	S9522, S9074, S9545, S9656
S9923	196	280	White	S9523, S9075

For interior products, the IP rating stated is from below the ceiling



Image courtesy of QCE,  
photography Indie Lane Tourquay



 SAL National Pty Ltd - 40 Biloela St, Villawood NSW 2163

 + 61 2 9723 3099

 [www.sal.net.au](http://www.sal.net.au)

 [info@sal.net.au](mailto:info@sal.net.au)

 VICT/TAS - 46/48 Keys Road Moorabbin VIC 3189

 + 61 3 9532 3168

 [info@sal.net.au](mailto:info@sal.net.au)

 QLD - 36 Whitelaw Place Richlands QLD 4077

 + 61 7 3879 5999

 [info@sal.net.au](mailto:info@sal.net.au)

 SA/NT - Unit 1, 9 Alfred Avenue Beverley SA 5009

 +61 8 7084 1958

 [info@sal.net.au](mailto:info@sal.net.au)

 WA - 29 Beringarra Avenue Malaga WA 6090

 +61 8 9248 7458

 [info@sal.net.au](mailto:info@sal.net.au)



**2024/25**

