



SINCE 1998



2024/25

**SMARTER
LIGHTING
CHOICES**



A comprehensive range of LED weatherproof luminaires with an extensive selection of wattages, sensor, dimming and mounting options.

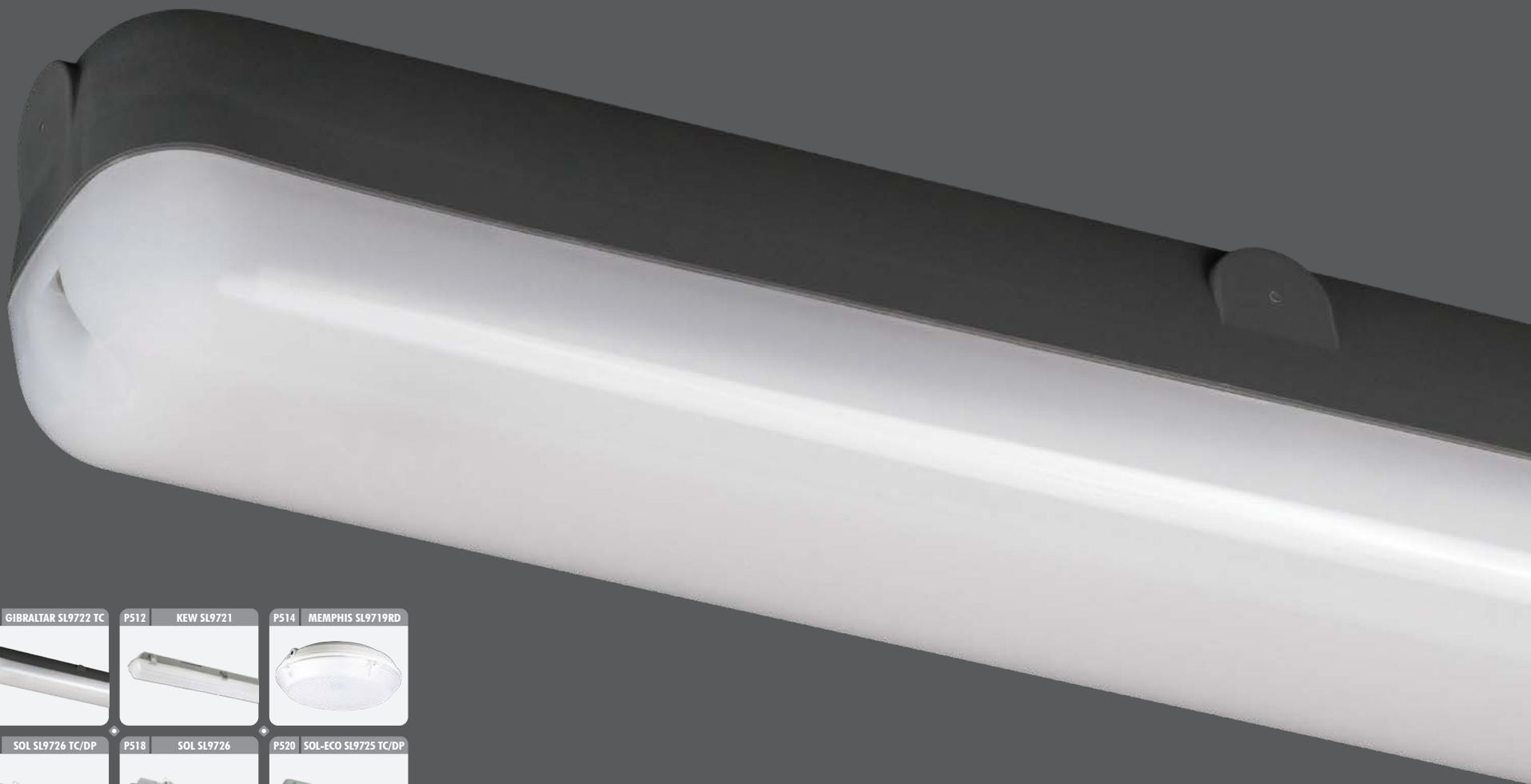



TC SELECTABLE COLOUR

BENNY SL2106 TC - 10W/24W

IP65 LED Oyster, wall or ceiling mount with selectable CCT and sensor options

Application

A perfect choice for apartments, residential or commercial spaces

Design Specifications

- Selectable CCT 3000 / 4000 / 6000K
- Durable polycarbonate body profile with an opal polycarbonate diffuser, colour white
- Rugged IK08 construction
- High efficiency LED optics, CRI >80
- Integrated sensor models available
- Optional corridorSTANDBY functions available
- Double insulated

Performance

- Non-dimmable



Technical Specifications

Model No.	Input (V)/(Hz)	Power (W)	Lumen (lm)	CCT (K)	CRI	Fitting Colour	Dimensions (Ø x H mm)
SL2106/20TC	240/50	10	800	3000/4000/6000	> 80	White	220 x 65
SL2106/30TC	240/50	20	1600	3000/4000/6000	> 80	White	280 x 71
SL2106/30TC/S	240/50	20	1600	3000/4000/6000	> 80	White	280 x 71
SL2106/40TC	240/50	24	2000	3000/4000/6000	> 80	White	350 x 81
SL2106/40TC/C	240/50	24	2000	3000/4000/6000	> 80	White	350 x 81



SL2106/20TC

Dimensions

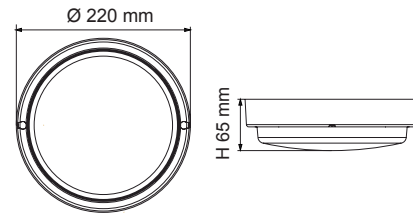

Photometric Data

Unit: cd C0/C180 — C90/C270

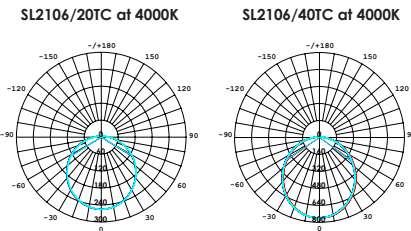

TC SELECTABLE COLOUR



SL2106/30TC



SL2106/40TC

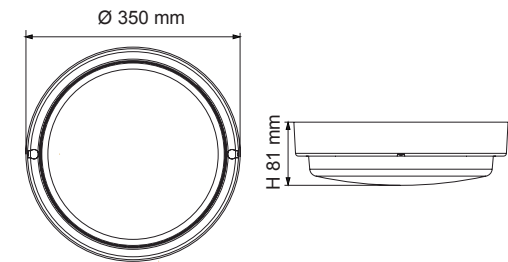
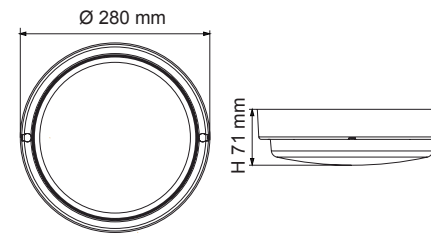

Technical Specifications

Integrated microwave motion sensor settings are **PRE-SET** and adjustable only by a qualified installer

Model No.	Detection Range	Daylight Threshold	Duration (mins.)
SL2106/30TC/S	100%	Disabled	10
SL2106/30TC/S1	100%	50 Lux	10
SL2106/30TC/S2	50%	50 Lux	5



Integrated microwave motion sensor with corridorSTANDBY function

Model No.	Detection Range	Daylight Threshold	Duration (mins.)	Standby Level	Standby Period
SL2106/40TC/C	100%	Disabled	12	20%	30 mins.
SL2106/40TC/C1	100%	50 Lux	6	30%	30 mins.
SL2106/40TC/C2	100%	50 Lux	6	20%	24 hrs.

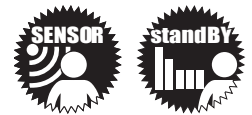

For terms of catalogue data use, refer to INDEX





TC SELECTABLE COLOUR



TC SELECTABLE COLOUR

GIBRALTAR SL9722 TC - 15W

IP66 LED vandal proof batten, ceiling mount, 15 watt selectable CCT

Application

Multi-purpose commercial or industrial utility applications

Design Specifications

- Rounded, 92mm profile design, robust UV resistant, (dark grey) nylon construction
- Stainless steel secure fastening screws, IK10 protection
- Operating temperature -20 °C to +40°C
- Integral constant current non-dimmable LED driver, with selectable CCT 3000/4000/5700K
- Large terminal block for easy installation
- Opal polycarbonate diffuser

Performance

- Non-dimmable



Photometric Data SL9722/15TC at 4000K

Unit: cd C0/C180 — C90/C270

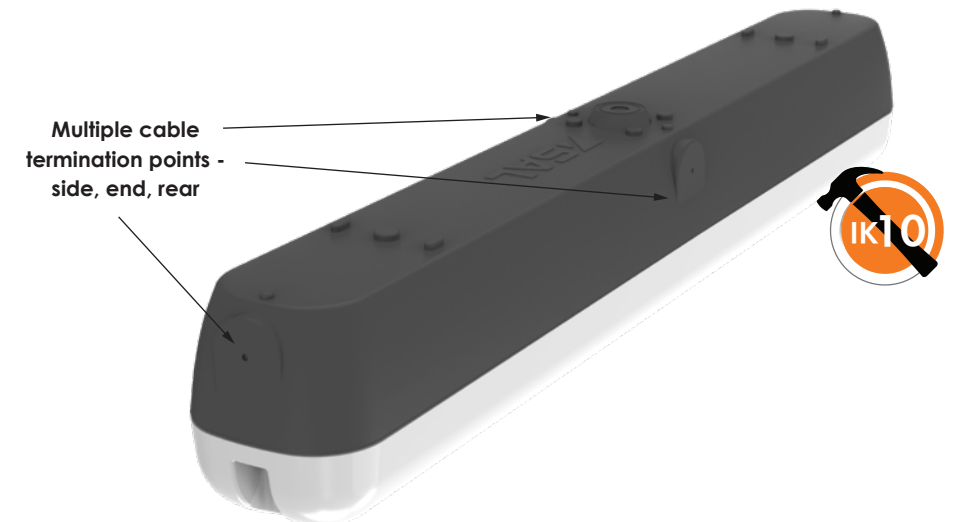
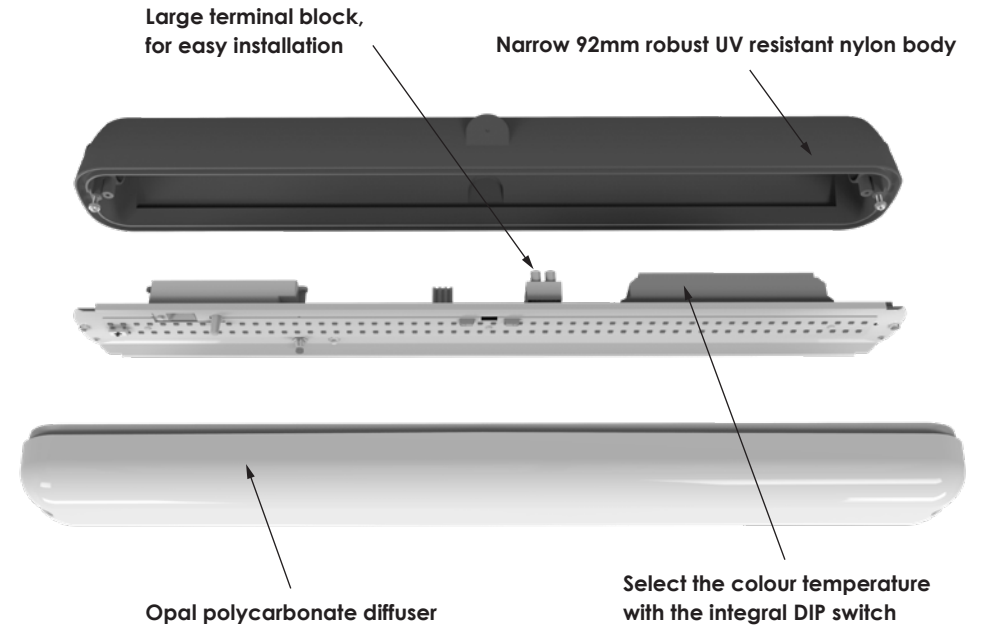
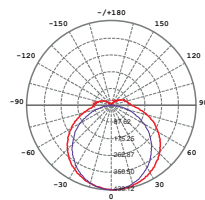

Technical Specifications

Model No.	Input (V)/(Hz)	Power (W)	Lumen (lm)	CCT (K)	CRI	Beam Angle	Fitting Colour	Dimensions (L x W x H mm)
SL9722/15TC	240/50	15	1500/1650/1650	3000/4000/5700	> 80	120°	Grey	660 x 92 x 105





KEW SL9721 - 20W/35W

IP65 LED weatherproof batten 20/35 watt selectable power and sensor options

Application

Multi-purpose ceiling mount or suspended, commercial or industrial applications

Design Specifications

- Vandal resistant design, robust polycarbonate body and UV stabilized polycarbonate diffuser
- Stainless steel clips & screws, IP65, IK08, sensor and emergency options
- Operating temperature -20°C to +40°C
- Integral non-dimmable LED driver
- Selectable power choices of 100%, 75% or 50%
- Optional corridorSTANDBY functions available

Performance

- Dimmable - optional, trailing edge, 1-10V, DALI, DSI
- Sensor - optional, microwave



Technical Specifications

Model No.	Input (V)/(Hz)	Power (W)	Lumen (lm)	CCT (K)	CRI	Beam Angle	Fitting Colour	Dimensions (L x W x H mm)
SL9721/20W WW	240/50	20	900/1800	3000	> 80	120°	Grey	618 x 116 x 74
SL9721/20W DL	240/50	20	900/1800	5000	> 80	120°	Grey	618 x 116 x 74
SL9721/20W/C	240/50	20	900/1800	5000	> 80	120°	Grey	618 x 116 x 74
SL9721/35W WW	240/50	35	1800/3600	3000	> 80	120°	Grey	1215 x 116 x 74
SL9721/35W DL	240/50	35	1800/3600	5000	> 80	120°	Grey	1215 x 116 x 74
SL9721/35W/C	240/50	35	1800/3600	5000	> 80	120°	Grey	1215 x 116 x 74

Photometric Data

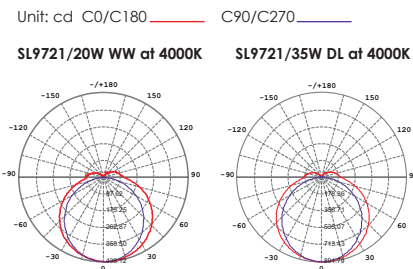

SL9721/20W



SL9721/35W



Sensor Options

- Integrated microwave motion sensor
- Integrated microwave motion sensor with corridorSTANDBY function

Emergency Options



Product selections compliant to AS/NZS2293 Emergency Lighting & Exit Signs are located in the interior and exterior emergency sections of this catalogue.

Surface/suspended mounting clips to maintain IP rating



Surface mounting bracket

Suspension bracket



Stainless steel clips can be fastened with extra locking screws for security

Accessories Included

- Allen key & screws
- PVC cable glands
- Suspension brackets

Installation type

- Surface mounted
- Suspended (Suspension kit is required)

For terms of catalogue data use, refer to INDEX





MEMPHIS ROUND SL9719RD - 22W

Vandal resistant, LED round profile, wall or ceiling mount luminaire, IK10, IP65

Application

A robust solution for industrial and commercial spaces

Design Specifications

- Die-cast aluminium body, frosted polycarbonate diffuser, silicone gasket
- Stainless steel allen screws
- High efficiency LED optics
- Integral non-dimmable LED driver
- Designed with multi access rear or side conduit entry points
- Optional (non-dim) corridorSTANDBY function available
- Product selections compliant to AS/NZS2293 Emergency Lighting & Exit Signs are located in the exterior emergency section of this catalogue.



Dimensions

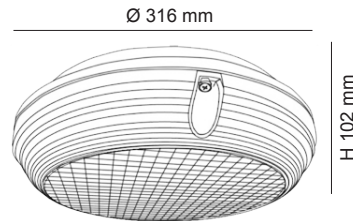

Performance

- Dimmable - optional, trailing edge, 1-10V, DALI / DSI
- Sensor - optional, microwave



Photometric Data SL9719RD at 4000K

Unit: cd C0/C180 — C90/C270

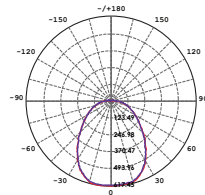

Technical Specifications

Model No.	Input (V)/(Hz)	Power (W)	Lumen (lm)	CCT (K)	CRI	Dimmable	Fitting Colour
SL9719RD	240/50	22	1700	4000	> 80	Optional	White
SL9719RD/C	240/50	22	1700	4000	> 80	Optional	White



MEMPHIS SQUARE SL9719SQ - 22W

Vandal resistant, LED square profile, wall or ceiling mount luminaire, IK10, IP65

Application

A robust solution for industrial and commercial spaces

Design Specifications

- Die-cast aluminium body, frosted polycarbonate diffuser, silicone gasket
- Stainless steel allen screws
- High efficiency LED optics
- Integral non-dimmable LED driver
- Designed with multi access rear or side conduit entry points
- Optional (non-dim) corridorSTANDBY function available
- Product selections compliant to AS/NZS2293 Emergency Lighting & Exit Signs are located in the exterior emergency section of this catalogue



Dimensions

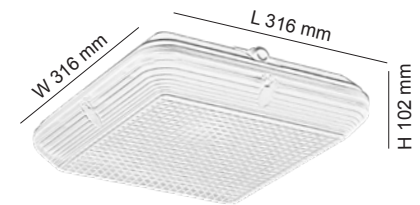

Performance

- Dimmable - optional, trailing edge, 1-10V, DALI / DSI
- Sensor - optional, microwave



Photometric Data SL9719SQ at 4000K

Unit: cd C0/C180 — C90/C270

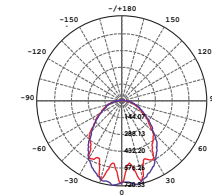

Technical Specifications

Model No.	Input (V)/(Hz)	Power (W)	Lumen (lm)	CCT (K)	CRI	Dimmable	Fitting Colour
SL9719SQ	240/50	22	1700	4000	> 80	Optional	White
SL9719SQ/C	240/50	22	1700	4000	> 80	Optional	White

For terms of catalogue data use, refer to INDEX





TC SELECTABLE COLOUR

DUAL POWER



TC SELECTABLE COLOUR

DUAL POWER

SOL SL9726 TC/DP - 10W/50W

Premium, IP65 LED weatherproof batten with selectable CCT and power

Application

Commercial or industrial ceiling or suspended mount applications requiring IP65 and IK08 performance

Design Specifications

- Selectable CCT 3000K/4000K/6000K
- Vandal resistant design, robust polycarbonate body and UV stabilized polycarbonate diffuser
- Stainless steel clips & screws
- Integral non-dimmable, dual power LED driver, 10/20 or 20/42 watt models
- Product selections compliant to AS/NZS2293 Emergency Lighting & Exit Signs are located in the interior and exterior emergency sections of this catalogue
- Optional (non-dim) corridorSTANDBY function available

Performance

- Dimmable - optional, trailing edge, 1-10V, DALI, DSI
- Sensor - optional, microwave
- Suspension wire kit - optional

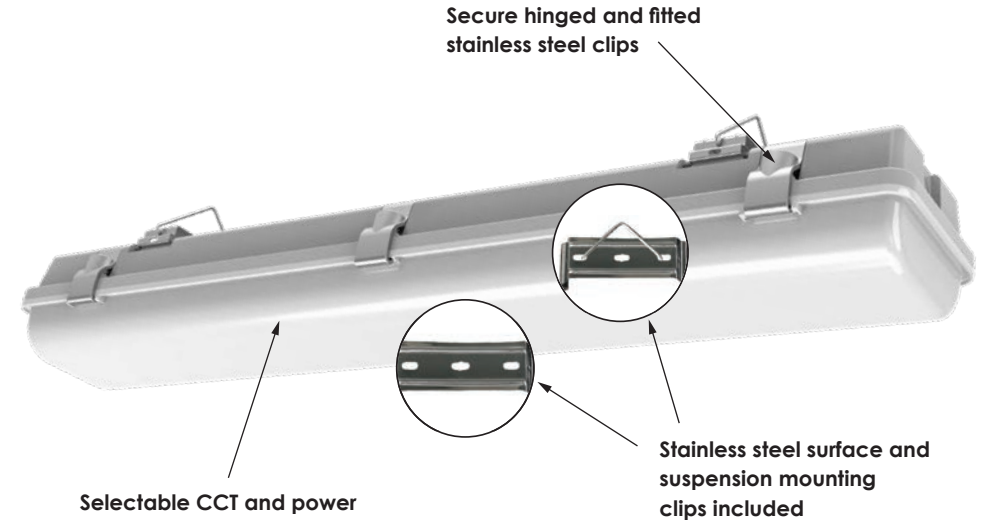

Photometric Data

Unit: cd C0/C180 — C30/C210 — C60/C240 — C90/C270

SL9726/20TC/DP at 4000K SL9726/40TC/DP at 4000K

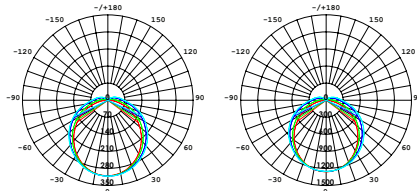

Technical Specifications

Model No.	Input (V)/(Hz)	Power (W)	Lumen (lm)	CCT (K)	CRI	Beam Angle	Dimensions (L x W x H mm)
SL9726/20TC/DP	240/50	10/20	1110/1190/1170 2040/2300/2200	3000/4000/6000	> 80	120°	642 x 118 x 77
SL9726/20TC/C	240/50	20	2200	3000/4000/6000	> 80	120°	642 x 118 x 77
SL9726/40TC/DP	240/50	20/42	2500/2670/2650 4370/4990/4720	3000/4000/6000	> 80	120°	1251 x 118 x 77
SL9726/40TC/C	240/50	42	4720	3000/4000/6000	> 80	120°	1251 x 118 x 77
SL9726/40TC/S	240/50	20/42	2500/2670/2650 4370/4990/4720	3000/4000/6000	> 80	120°	1251 x 118 x 77
SL9726/50TC/DP	240/50	30/50	3670/3970/3950 5480/6070/5920	3000/4000/6000	> 80	120°	1551 x 118 x 77

For terms of catalogue data use, refer to INDEX





SOL SL9726 - 10W/42W

IP65 LED weatherproof batten with dual colour selections and power

Application

Commercial or industrial ceiling or suspended mount applications requiring IP65 and IK08 performance

Design Specifications

- Dual colour selections Blue or Green, Red or Amber
- Rounded shape vandal resistant design, robust polycarbonate body and UV stabilized polycarbonate diffuser
- 304 Stainless steel clips & screws, 20mm cable gland entry
- Integral constant current non-dimmable LED driver, with dual power selections
- Optional (non-dim) corridorSTANDBY functions available

Performance

- Dimmable - optional
- Sensor - optional, microwave
- Suspension wire kit - optional



Wavelength / CCT

Blue: 450 - 470 nm
Green: 510 - 530 nm
Amber: 1800 K
Red: 615 - 635 nm

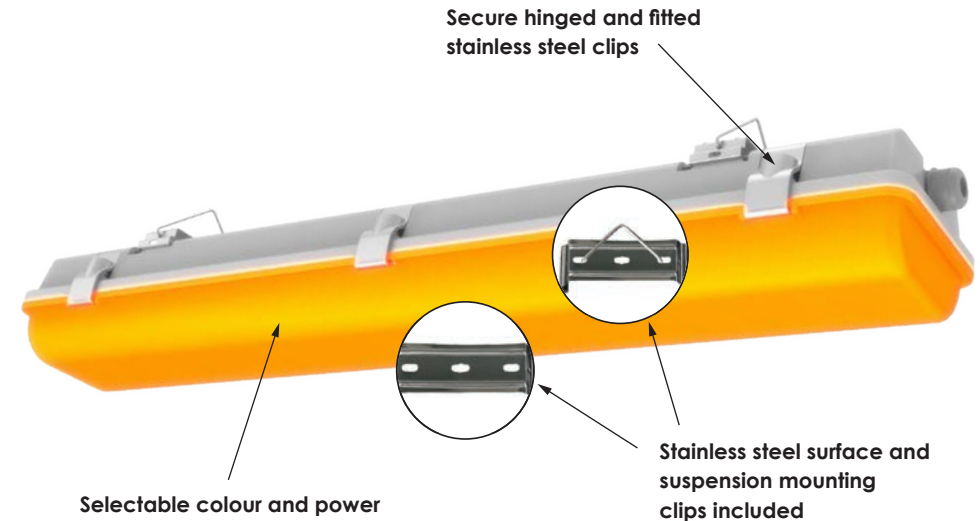

Technical Specifications

Model No.	Input (V)/(Hz)	Power (W)	Body Colour	Beam Angle	Fitting Colour	Dimensions (L x W x H mm)
SL9726/20BU/GN	240/50	10/20	Blue / Green	120°	Grey	642 x 118 x 77
SL9726/20AM/RD	240/50	10/20	Amber / Red	120°	Grey	642 x 118 x 77
SL9726/40BU/GN	240/50	20/42	Blue / Green	120°	Grey	1251 x 118 x 77
SL9726/40AM/RD	240/50	20/42	Amber / Red	120°	Grey	1251 x 118 x 77

For terms of catalogue data use, refer to INDEX





TC SELECTABLE COLOUR
DUAL POWER

SOL-ECO SL9725 TC/DP - 10W/40W

IP65 LED weatherproof batten with selectable CCT and power

Application

Commercial or industrial ceiling or suspended mount applications requiring IP65 and IK08 performance

Design Specifications

- Selectable CCT 3000K/4000K/6000K
- Rounded shape vandal resistant design, robust polycarbonate body and UV stabilized polycarbonate diffuser
- Integral constant current non-dimmable, dual power LED driver, 10/20 or 20/40 watt models
- Product selections compliant to AS/NZS2293 Emergency Lighting & Exit Signs are located in the interior and exterior emergency sections of this catalogue

Performance

- Non-dimmable
- Suspension wire kit - optional



TC SELECTABLE COLOUR
DUAL POWER

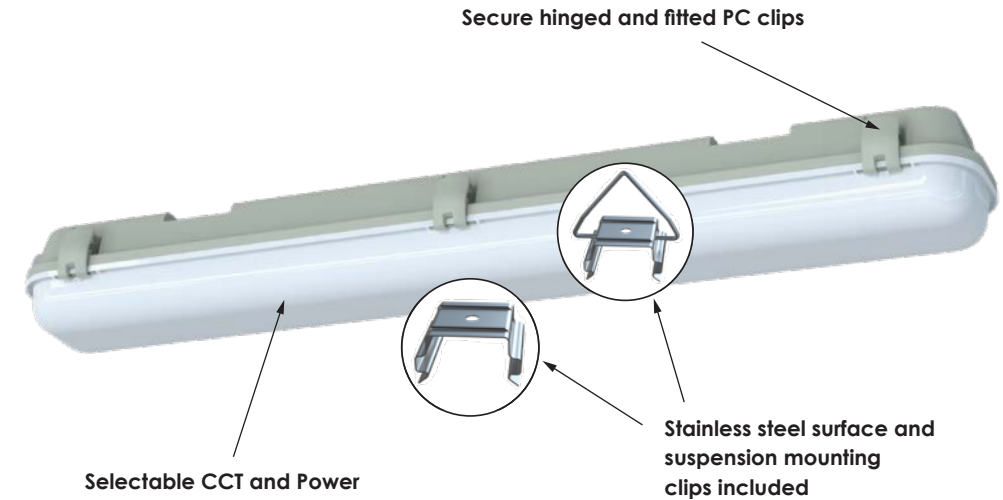

Photometric Data

Unit: cd C0/C180 — C30/C210
cd C60/C240 — C90/C270

SL9725/20TC/DP at 4000K SL9725/40TC/DP at 4000K

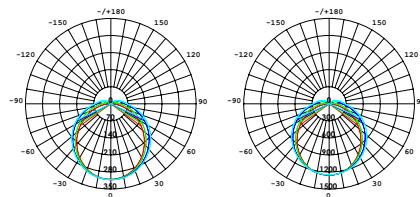

Technical Specifications

Model No.	Input (V)/(Hz)	Power (W)	Lumen (lm)	CCT (K)	CRI	Beam Angle	Dimensions (L x W x H mm)
SL9725/20TC/DP	240/50	10 20	1200/1300/1250 2100/2300/2150	3000/4000/5700	> 80	120°	653 x 99 x 76
SL9725/40TC/DP	240/50	20 40	2350/2500/2450 4100/4500/4200	3000/4000/5700	> 80	120°	1253 x 99 x 76

For terms of catalogue data use, refer to INDEX





 SAL National Pty Ltd - 40 Biloela St, Villawood NSW 2163

 + 61 2 9723 3099

 www.sal.net.au

 info@sal.net.au

 VICT/TAS - 46/48 Keys Road Moorabbin VIC 3189

 + 61 3 9532 3168

 info@sal.net.au

 QLD - 36 Whitelaw Place Richlands QLD 4077

 + 61 7 3879 5999

 info@sal.net.au

 SA/NT - Unit 1, 9 Alfred Avenue Beverley SA 5009

 +61 8 7084 1958

 info@sal.net.au

 WA - 29 Beringarra Avenue Malaga WA 6090

 +61 8 9248 7458

 info@sal.net.au



2024/25

